

Table of Contents

1: General Description	1
1.1 Introduction	1
1.2 Principles of Operation	2
1.3 Supplied Hardware	3
1.4 U3000/U4000 Instrument	4
1.4.1 Connections	4
1.4.2 Keypad	5
1.4.3 Power supply	6
2: Installation	7
2.1 Safety Precautions and Warnings	7
2.2 Installing the U3000/U4000 Instrument	7
2.2.1 Positioning the instrument	7
2.2.2 Mounting the instrument	7
2.2.3 Connecting the instrument	9
2.3 Installing the Ultrasonic Transducers	10
2.3.1 Transducer positioning	10
2.3.2 Transducer attachment	12
2.3.3 Attaching the guide rail to the pipe	12
2.3.4 Fitting the transducers	13
2.3.5 Transducer attachment (diagonal mode)	15
2.4 Installing the USB Virtual Com. Port (U4000 only)	17
3: Operating Procedures	19
3.1 Setting-up the Instrument	20
3.1.1 Using the instrument for the first time	20
3.1.2 Changing the user language	21
3.1.3 Changing the date and time [*U4000 only]	21
3.2 Using the Quick Start Menu	21
3.3 Instrument Calibration	25
3.3.1 Adjusting the zero cut-off	25
3.3.2 Adjusting the set zero flow offset	25
3.3.3 Adjusting the calibration factor	26
3.3.4 Adjusting the roughness factor	27
3.3.5 Adjusting the damping factor	28
3.4 Outputs	29
3.4.1 Current output	29
3.4.2 Pulse output (for Pulse Frequency Output see Page 44)	31

3.4.3 Alarm outputs	31
3.5 How to Measure Totalised Flows (manually)	34
3.6 Display of totalisers	35
3.7 Setting the Chiller Options	35
3.7.1 Setting the Chiller Delay	36
4: Data Logging & Communications (U4000)	37
4.1 How to Set Up the Basic Logging Application to Memory	37
4.2 How to Set Up Automatic (Timed) Logging Mode	39
4.3 How to Log Directly to a PC	41
4.4 How to Log Directly to Both Memory and PC	41
4.5 How to Download Logged Data to a PC	41
4.6 Working with Portagraph III	42
4.7 Printing	42
4.7.1 How to print logged data using the RS232 printer	42
4.8 Operation with the Calec®ST Energy Totaliser	44
4.8.1 Pulse output	44
4.8.2 Connecting the U3000/U4000 to the Calec® ST Energy Totaliser	44
4.8.3 Configuring the U3000/U4000	44
4.8.4 Configuring the Calec® ST Energy Totaliser	46
5: Maintenance & Repair	47
6: Troubleshooting	49
6.1 Overview	49
6.2 General Troubleshooting Procedure	50
6.3 Warning and Status Messages	51
6.4 Diagnostics Display	54
7: Options	55
7.1 Options Common to Both the U3000/U4000	55
7.1.1 Large pipe diameter transducers	55
7.1.2 Guide rail options	55
7.1.3 Extended signal cable options	55
Appendix A: Specification	57

1: General Description

1.1 Introduction

This manual describes the operation of the U3000/U4000 flowmeter. The flowmeter is designed to work with clamp-on transducers to enable the flow of a liquid within a closed pipe to be measured accurately without needing to insert any mechanical parts through the pipe wall or protrude into the flow system.

Using ultrasonic *transit time* techniques, the U3000/U4000 is controlled by a micro-processor system which contains a wide range of data that enables it to be used with pipes having an outside diameter ranging from 13mm up to 2000mm (5000mm with D sensors) and constructed of almost any material. The instrument will also operate over a wide range of fluid temperatures.

The basic features of the U3000 and U4000 are identical. However, the standard U4000 can also perform data logging, has RS232 and USB communications interfaces.

U3000/U4000 standard features:

- Large, easy to read graphic display with backlight.
- Simple to follow dual function keypad.
- Simple 'Quick Start' set up procedure.
- Continuous signal monitoring.
- Isolated pulse output (volumetric or frequency).
- Isolated current output (4-20mA, 0-20mA or 0-16mA).
- 2x Isolated programmable alarm outputs.
- Password-protected menu operation for secure use.
- Signal diagnostics.
- Multi-function alarm outputs.
- Operates from Mains, 24Va.c. or 24Vd.c.

U4000 additional standard features:

- 200k stored data points.
- Logging of Flows and Volume totals.
- RS232 and USB output.

Volumetric flow rates are displayed in l/h, l/min, l/sec, gal/min, gal/h, USgals/min, USgals/h, Barrel/h, Barrel/day, m³/s, m³/min, m³/h. Linear velocity is displayed in metres or feet per second.

When operating in the 'Flow Reading' mode the total volumes, both positive and negative, are displayed up to a maximum 12-digit number.

The flowmeter can be used to measure clean liquids or oils that have less than 3% by volume of particulate content. Cloudy liquids such as river water and effluent can be measured along with cleaner liquids such as demineralised water.

Typical U3000/U4000 applications include:

- River water.
- Seawater.
- Potable water.
- Demineralised water.
- Treated water.

Both the U3000 and U4000 have 'A' and 'B' model options, which refer to the transducer type provided. Thus a U3000A will be supplied with type 'A' transducers which are designed to work with pipe diameters between 13mm - 115mm; whereas a U4000B will be supplied with type 'B' transducers which are designed to work with pipe diameters between 50mm - 2000mm. Both sets of transducers use a common mounting system for

pipe attachment. Throughout this manual any reference to 'U3000/U4000' applies to both U3000A/B and U4000A/B model variants unless otherwise stated.

Note: In addition to the 'A' and 'B' type sensors, type 'D' sensors (option) are available for use on pipes up to 5000mm. These have a different mounting method. See [Paragraph 1.3](#) for further details.

1.2 Principles of Operation

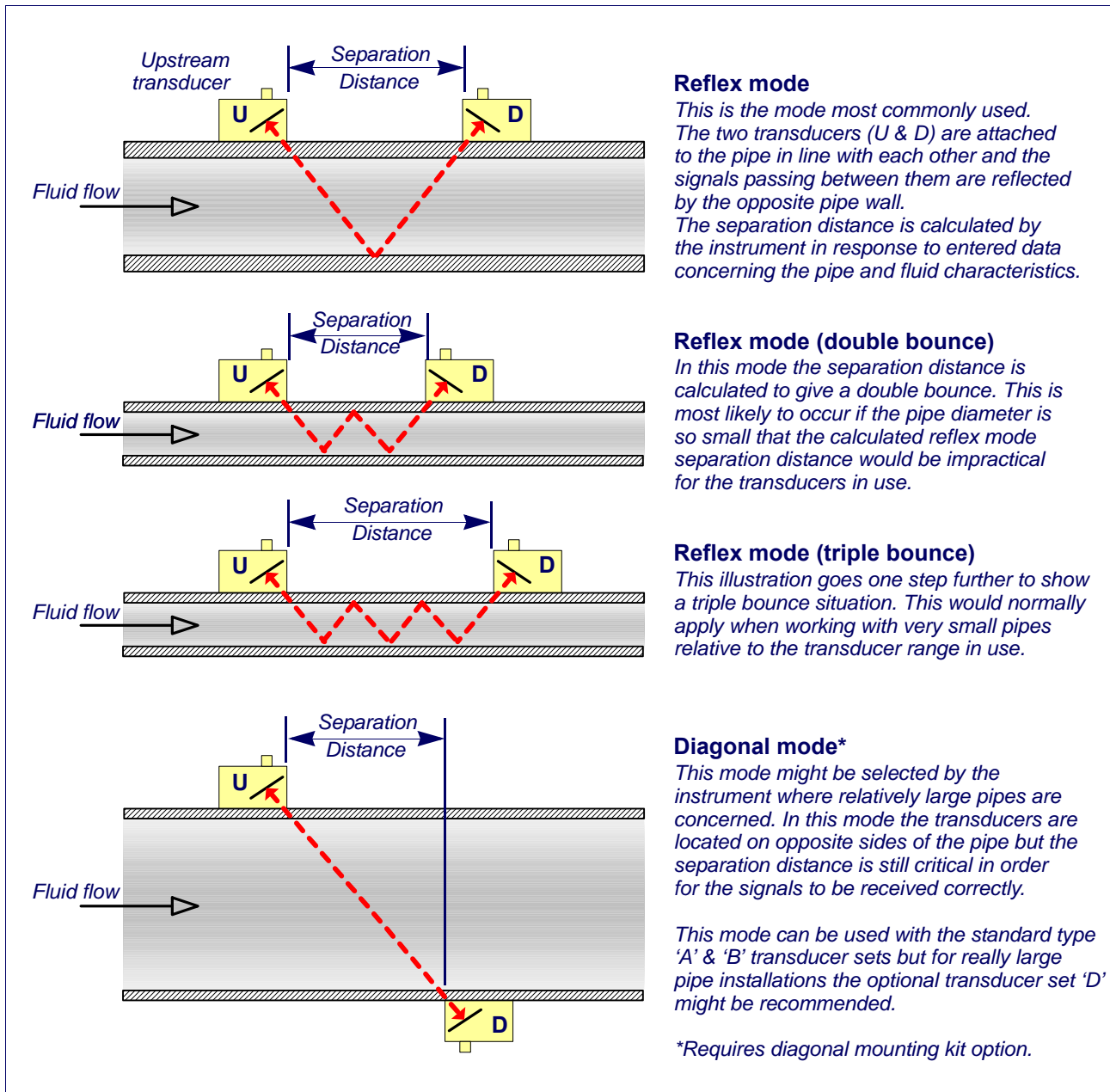

Figure 1.1 Operating modes

When ultrasound is transmitted through a liquid the speed at which the sound travels through the liquid is accelerated slightly if it is transmitted in the same direction as the liquid flow and decelerated slightly if transmitted against it. The difference in time taken by the sound to travel the same distance but in opposite directions is therefore directly proportional to the flow velocity of the liquid.

The U3000/U4000 system employs two ultrasonic transducers attached to the pipe carrying the liquid and compares the time taken to transmit an ultrasound signal in each direction. If the sound characteristics of the fluid are known, the instrument's microprocessor can use the results of the transit time calculations to compute the fluid flow velocity. Once the flow velocity is known the volumetric flow can be easily calculated for a given pipe diameter.

The system can be set up to operate in one of four modes determined mainly by the pipe diameter and the type of transducer set in use. The diagram in [Figure 1.1](#) illustrates the importance of applying the correct separation distance between the transducers to obtain the strongest, and therefore most reliable, signal.

1.3 Supplied Hardware

The supplied U3000/U4000 components are shown in [Figure 1.2](#).



Figure 1.2 Standard U3000/U4000 equipment

U3000/U4000 Standard equipment

- Instrument with backlit graphic display.
- Transducer cables (x2) 5 metres long.
- Transducers 'A-ST' x2 (U3000/U4000A) for use with pipes ranging 13mm – 115mm.
- Transducers 'B-ST' x2 (U3000/U4000B) for use with pipes ranging 50mm – 2000mm.
- USB cable (U4000).
- Guide rail for use with 'A' or 'B' transducers.
- Steel bands used to secure the transducer guide rails to the pipe.
- Acoustic couplant.
- User documentation.

U3000/U4000 Optional equipment

- Transducer set 'D' - used for monitoring pipes of 1500mm to 5000mm diameter, over a temperature range -20°C to +80°C. This kit is supplied in a separate case and includes the sensors together with ratchet straps and guide rails for attaching to the pipe.

1.4 U3000/U4000 Instrument

The U3000/U4000 is a microprocessor controlled instrument operated through a menu system using an inbuilt LCD display and keypad. It can be used to display the instantaneous fluid flow rate or velocity, together with totalised volumes. The instrument can also provide an isolated current output, or variable pulse output, proportional to the measured flow rate which can be scaled to suit a particular flow range. Finally, two isolated alarm outputs are provided which can be configured in a number of ways. For example, to operate when the flow rate exceeds a specified maximum or minimum limit.

In addition, the U4000 can function as a data logger. When operating in this mode the logged data can be output to the instrument's memory, to a PC (via the RS232 or USB serial interfaces), or simultaneously to both memory and PC. When logging to memory only, the logged data can be downloaded to the PC at a later time. Both the flow rate and +/- Totals can be logged, with up to 200k logging events stored internally.

1.4.1 Connections

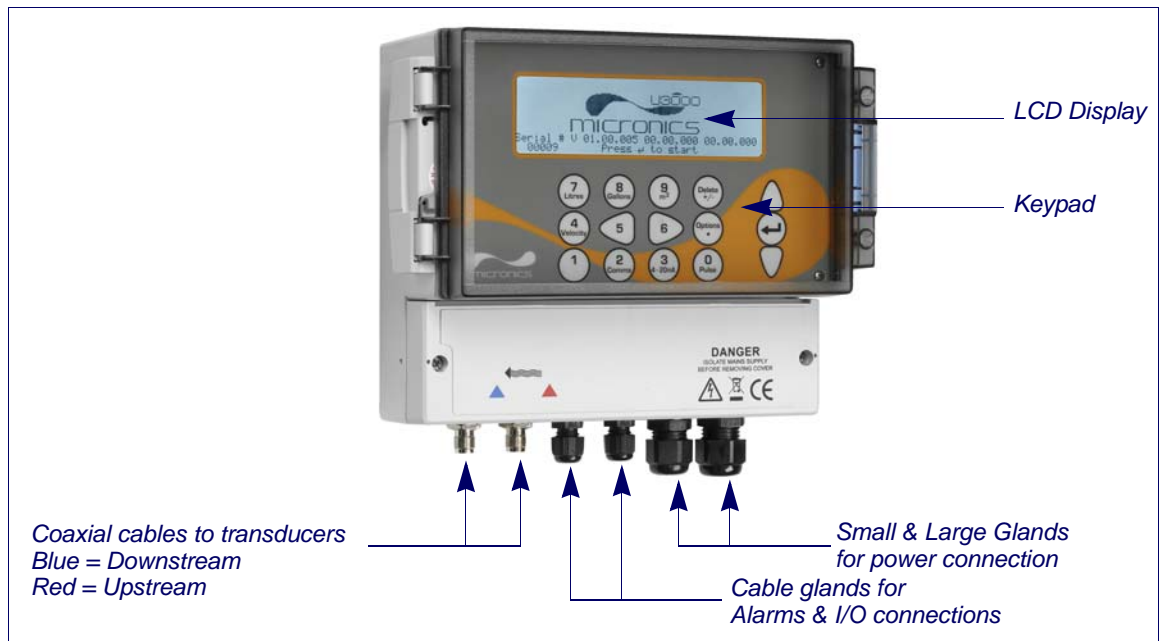

Figure 1.3 Instrument details

Transducer connections

The transducers are connected to two coaxial sockets located on the bottom left-hand of the instrument. The silk-screen above these connectors show a red and blue triangle and a direction of flow symbol. For a positive flow reading, it is important that the upstream transducer is connected to the RED socket and the downstream transducer to the BLUE one. It is safe to connect or disconnect the cable while the instrument is switched on.

USB connection (U4000 only)

A USB cable is supplied as part of the U4000 kit and can be connected between the U4000 instrument and a PC to download logged data. The USB connector, located on the top left hand side of the flowmeter as shown in [Figure 2.2](#), uses a Bulgin screwed type mini-USB connector to preserve the enclosure's IP 65 rating.

RS232 Connection (U4000 only)

A set of terminal blocks is provided for the RS232 connection, the cable to be routed via either of the alarm and I/O cable glands see [Figure 1.3](#).

4-20mA, 'Pulse', and Alarm I/O connections

The 4-20mA, 'pulse', and alarm I/O cables enter the bottom of the instrument via two cable glands and are connected internally to a terminal block. Full details of the terminal connections are provided in Chapter 2 (Installation) and Chapter 7 (Options).

Power supply

Two cable glands on the bottom right-hand side of the instrument are available for the power supply cable. Two sizes of glands are provided to accept cables of different diameters.

1.4.2 Keypad

The instrument is configured and controlled via a 15-key tactile membrane keypad, as shown in [Figure 1.4](#).

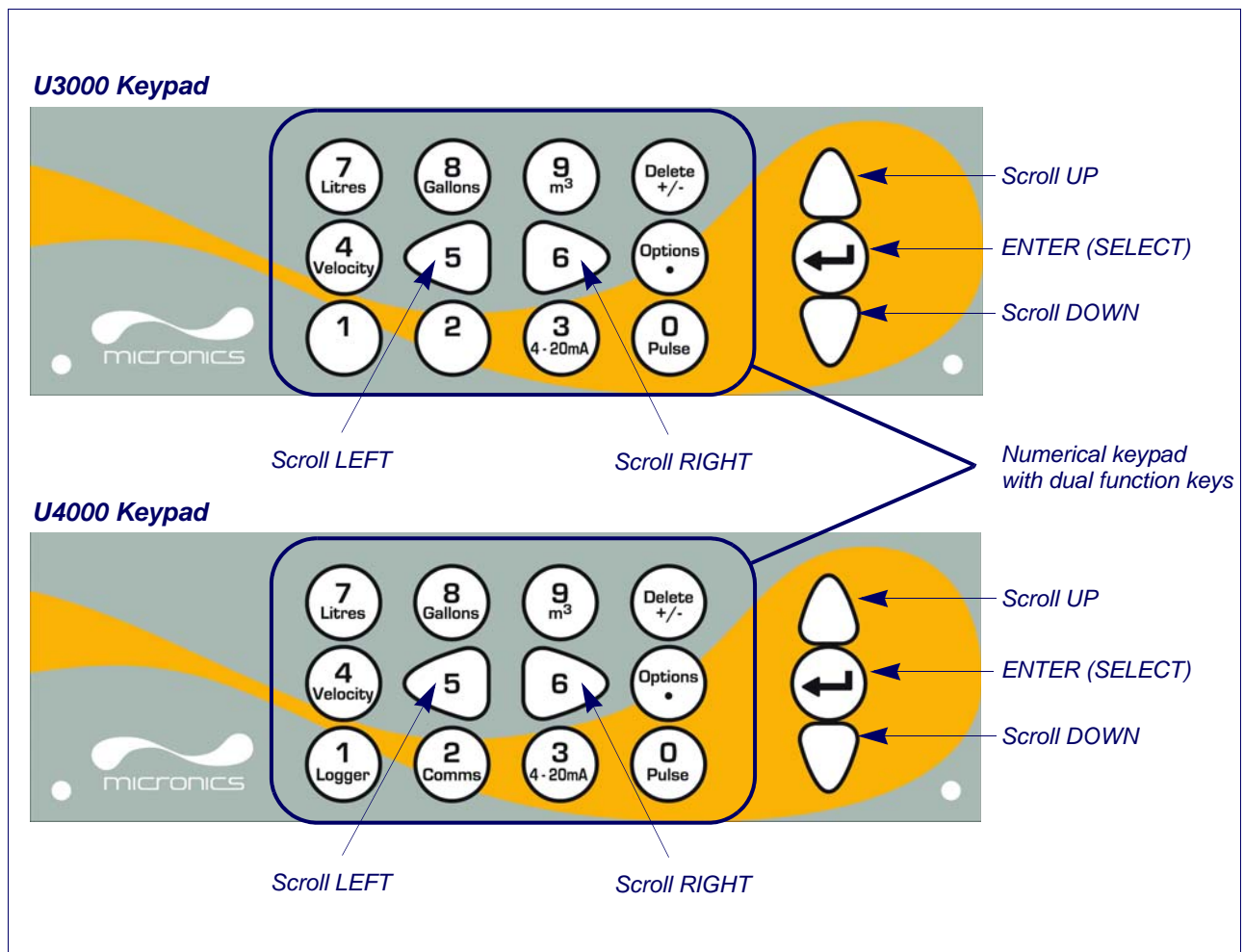

Figure 1.4 U3000/U4000 Keypad

Menus and the menu selection keys

Note: As a security measure, once the instrument has been set-up for the first time a password is required to gain subsequent access to the operating menus (see Page 24).

The U3000/U4000 menus are arranged hierarchally with the MAIN MENU being at the top level. Menu navigation is achieved by three keys located on the right hand side of the keypad which are used to scroll UP and DOWN a menu list and SELECT a menu item. When scrolling through a menu an arrow-shaped cursor moves up and down the left hand side of the screen to indicate the active menu choice which can then be selected by pressing the ENTER (SELECT) key.

Some menus have more options than can be shown on the screen at the same time, in which case the overflowed choices can be brought into view by continuing to scroll DOWN past the bottom visible item. Menus generally 'loop around' if you scroll beyond the first or last items.

If you select Exit on any menu it usually takes you back one level in the menu hierarchy, but in some cases it may go directly to the 'Flow Reading' screen.

Some screens require you to move the cursor left and right along the display as well as up and down. This is achieved using keys 5 (scroll LEFT) and 6 (scroll RIGHT).

Dual function numerical keypad

The block of keys shown in the centre of the keypad in [Figure 1.4](#) are dual function keys. They can be used to enter straight-forward numerical data, select the displayed flow units or provide quick access to frequently required control menus.

1.4.3 Power supply

Mains supply

As standard, the instrument is designed to work with a mains supply of 86-236V and 50/60Hz. A mains supply fuse is located adjacent to the mains power connection (see [Figure 2.3](#)).

24V Supply

An alternative 24V a.c./d.c. power supply module is available as a factory (distributor) fitted option.





Power failure

The instrument will automatically power-up and become operational when the input power is applied. In the event of a power failure the instrument's configuration parameters are stored in non-volatile memory, which then allows the instrument to return to normal operation immediately power is restored.

On the U4000 a real time clock (RTC) records the date/time of any power disruptions and time-stamps any such occurrence in the output log. All data logging ceases while power is unavailable.

2: Installation

2.1 Safety Precautions and Warnings

 WARNING	LETHAL VOLTAGES You may be exposed to potentially lethal (mains) voltages when the terminal cover of this instrument is removed. Always isolate the supply to this instrument before removing the terminal cover.
 WARNING	LETHAL VOLTAGES This instrument must be installed by an electrically qualified technician aware of the potential shock hazards presented when working with mains powered equipment.
 WARNING	SUPPLY EARTHING If the equipment is powered from a 24V AC supply then the supply must be isolated from Earth.
 Caution	IP65 Enclosure Protection <i>Blanking plugs are fitted to the cable glands on leaving the manufacturer. In order to preserve the enclosure's IP65 rating, ensure that the blanking plugs remain fitted in any unused cable gland.</i>

2.2 Installing the U3000/U4000 Instrument

2.2.1 Positioning the instrument

The U3000/U4000 instrument should be installed as close as conveniently possible to the pipe-mounted ultrasonic sensors. Standard transducer cables are 5 metres in length with 10 metre cables being optionally available. Where, for operational reasons, it is not possible to mount the instrument this close to the sensors, bespoke cables of up to 100m can be provided – consult Micronics Ltd for further information and availability.

A suitable mains supply must be available to power the instrument (an optional 24V a.c./d.c. supply module is available). The external supply must be suitably protected and connected via an identifiable isolator. A 500mA fuse is fitted internally in the instrument's input supply line.

2.2.2 Mounting the instrument

Ideally the U3000/U4000 enclosure should be fixed to a wall using three M4 screws – see [Figure 2.3](#).

1. Remove the U3000/U4000 terminal cover.

2. Fix a screw into the wall at the required point to align with the mounting keyhole on the back of the enclosure.
3. Attach the enclosure to the wall using the keyhole screw mounting.
4. Align the enclosure then mark out the positions for the two remaining screw fixings through the slots near the bottom corners of the enclosure. Then remove the enclosure, and drill (and plug) the fixing points.
5. Clear the site of any dust/debris then mount the enclosure on the wall.

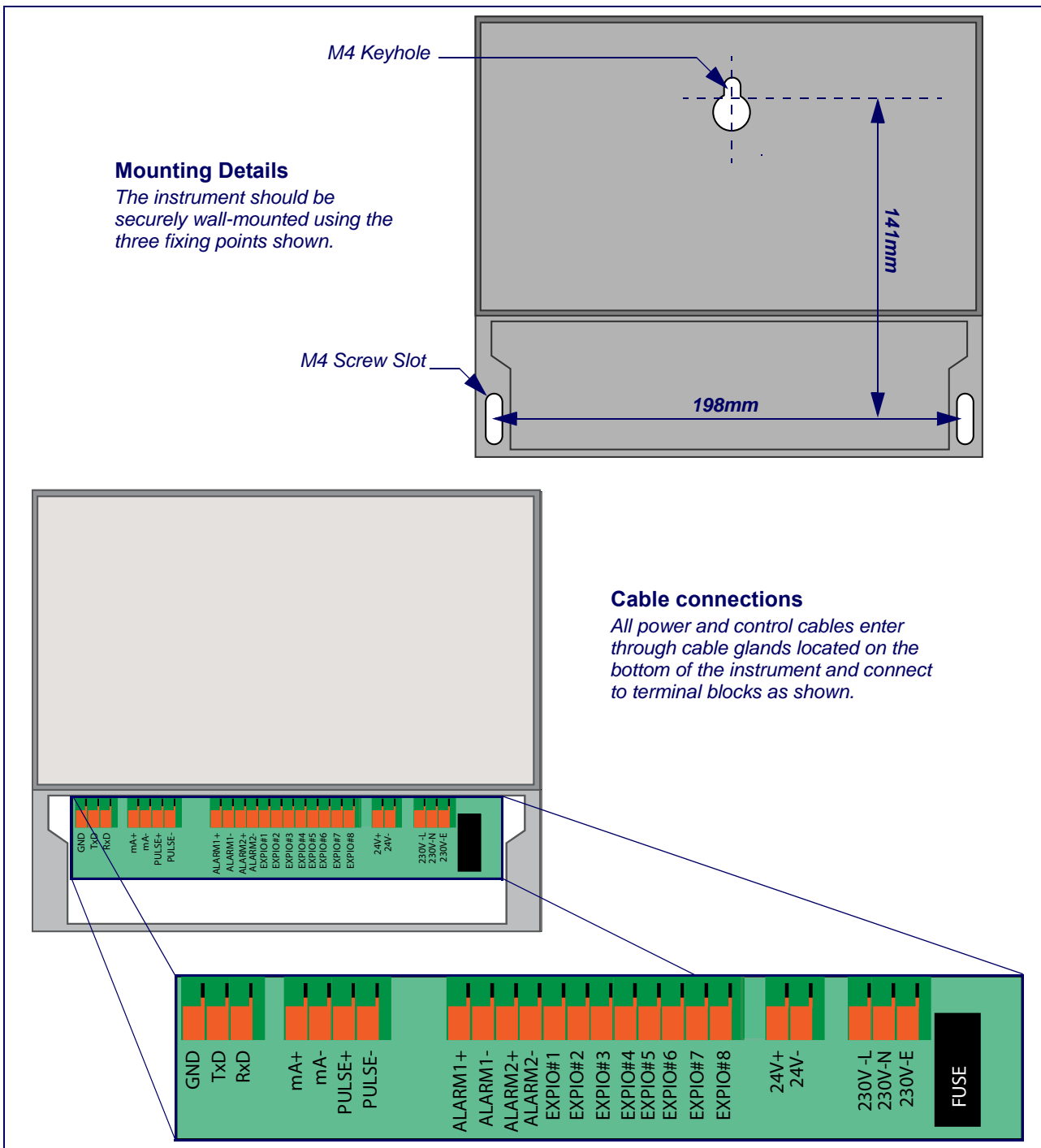

Figure 2.1 U3000/U4000 Mounting and connection details

2.2.3 Connecting the instrument

All cables enter the instrument through the (4) cable glands provided and are connected to terminal blocks which are located behind a safety cover. The terminal blocks use a spring-loaded securing mechanism which is opened by lifting the orange tab situated on the top of the terminal connection.

Control & monitoring cables

Depending on the fitted options, any of the following control and monitoring cables may be required:

- *Current output* – a 4-20mA, 0-16mA, or 0-20mA monitoring signal is output at terminal mA+ and mA-. (mA+ is the current output terminal and mA- is the return terminal).
- *Pulse output* – an opto-isolated pulse output is available at terminals PULSE+ and PULSE- (PULSE+ is the pulse output terminal and PULSE- is the return terminal).
- *Alarm Outputs* – two programmable, multifunction alarm outputs are available using MOSFET, SPNO relays. The relays are rated at 48V/500mA continuous load, and are connected to terminals ALARM1+, ALARM1-, ALARM2+ and ALARM2- respectively.
- *RS232 Interface (U4000 only)* – an RS232 interface is provided to allow logged data to be downloaded to a PC or RS232 compatible printer. The interface is connected to terminal TxD (data transmitted from the U4000) RxD (data received by the U4000) and GND (signal ground).
- *Expansion ports (U4000 only)* – terminals EXP10#1 to EXP10#8 are used for I/O connections to a number of optional expansion boards that may be fitted to the U4000 expansion slot.

1. Remove the terminal block cover.
2. Route the control and monitoring cables through the two smaller cable glands.
3. Cut the wires to length, strip back the insulation by approximately 10mm and connect them into the required terminals as described above and identified in [Figure 2.1](#).
4. On completion, tighten the cable glands to ensure the cables are held securely.

USB Connection (U4000 only)



Figure 2.2 U4000 USB Connection

A Mini-USB connector is available at the left-hand side of the enclosure to which the USB cable (provided) can be attached, as shown in [Figure 2.2](#). The free end of the USB cable can be plugged directly into any PC USB port.

Power connections



LETHAL VOLTAGES

Ensure the power cable is isolated from the mains supply.
Do not apply mains voltage with the terminal cover removed.



SUPPLY EARTHING

If the equipment is powered from a 24V AC supply then the supply must be isolated from Earth.

The instrument can be powered from a mains supply (86 - 264V a.c., 47/63Hz) or from a 24V a.c./d.c. supply if it is fitted with a 24V supply module.

1. Route the power cable through one of the two cable glands on the right hand side of the instrument, below the power connection terminals, using the gland most suitable for the cable diameter.
2. Cut the wires to length, strip back the insulation by approximately 10mm and connected to them into the correct power supply terminals identified in [Figure 2.1](#).
3. On completion, tighten the cable glands to ensure the cables are held securely.
4. Refit the terminal block cover.

2.3 Installing the Ultrasonic Transducers

2.3.1 Transducer positioning

To obtain the most accurate results the condition of both the liquid and the pipe wall must be suitable to allow the ultrasound transmission along its predetermined path. It is important also that the liquid flows uniformly within the length of pipe being monitored and that the flow profile is not distorted by any upstream or downstream obstructions. This is best achieved by ensuring there is a straight length of pipe upstream of the transducers of at least 20 times the pipe diameter and 10 times the pipe diameter on the downstream side, as shown in [Figure 2.3](#). Flow measurements can be made on shorter lengths of straight pipe, down to 10 diameters upstream and 5 diameters downstream, but when the transducers are positioned this close to any obstruction the resulting errors can be unpredictable.

Preparation



Key Point: Do not expect to obtain accurate results if the transducers are positioned close to any obstructions that distort the uniformity of the flow profile.

Micronics limited accepts no responsibility or liability if product has not been installed in accordance with the installation instructions applicable to the product.

Before you attach the transducers you should first ensure that the proposed location satisfies the distance requirements shown in [Figure 2.3](#) otherwise the resulting accuracy of the flow readings may be affected.

Prepare the pipe by degreasing it and removing any loose material or flaking paint in order to obtain the best possible surface. A smooth contact between pipe surface and the face of the transducers is an important factor in achieving a good ultrasound signal strength, and therefore maximum accuracy.

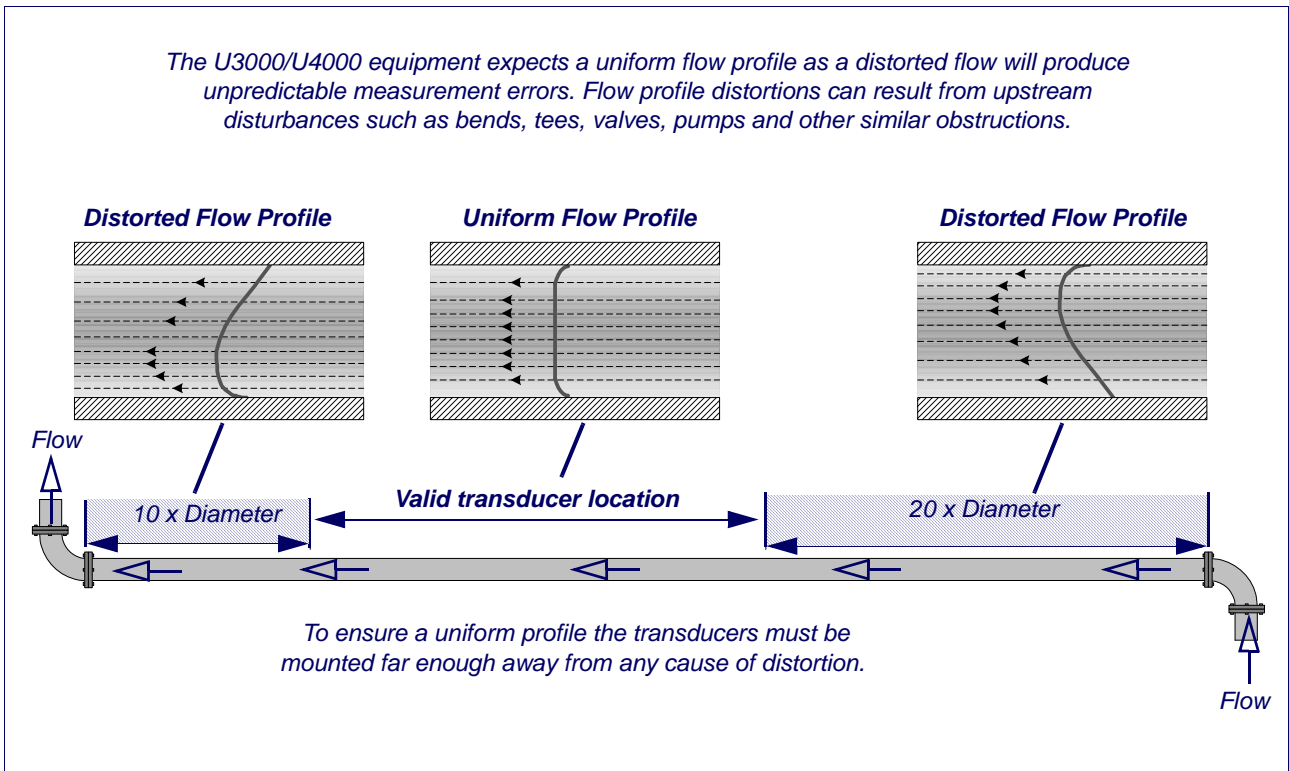

Figure 2.3 Locating the transducers

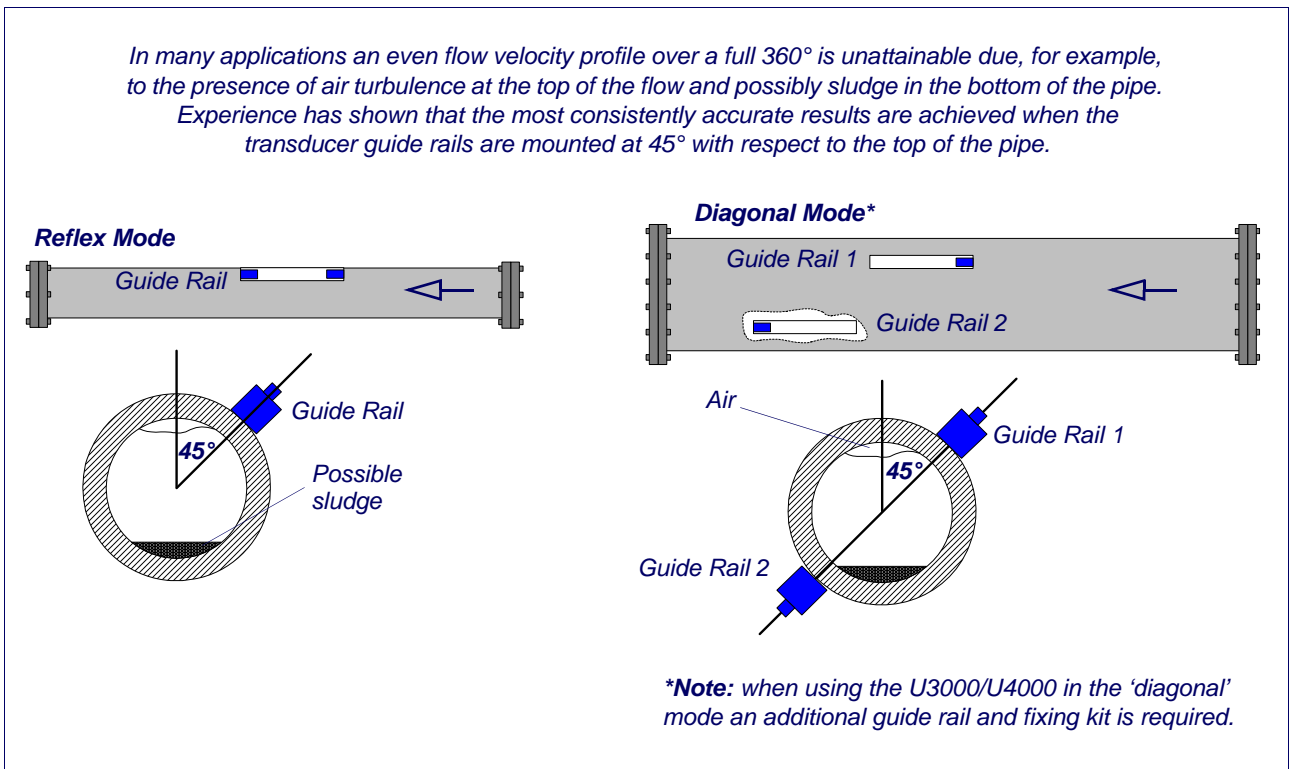

Figure 2.4 Guide rail attachment (reflex vs. diagonal mode)

2.3.2 Transducer attachment

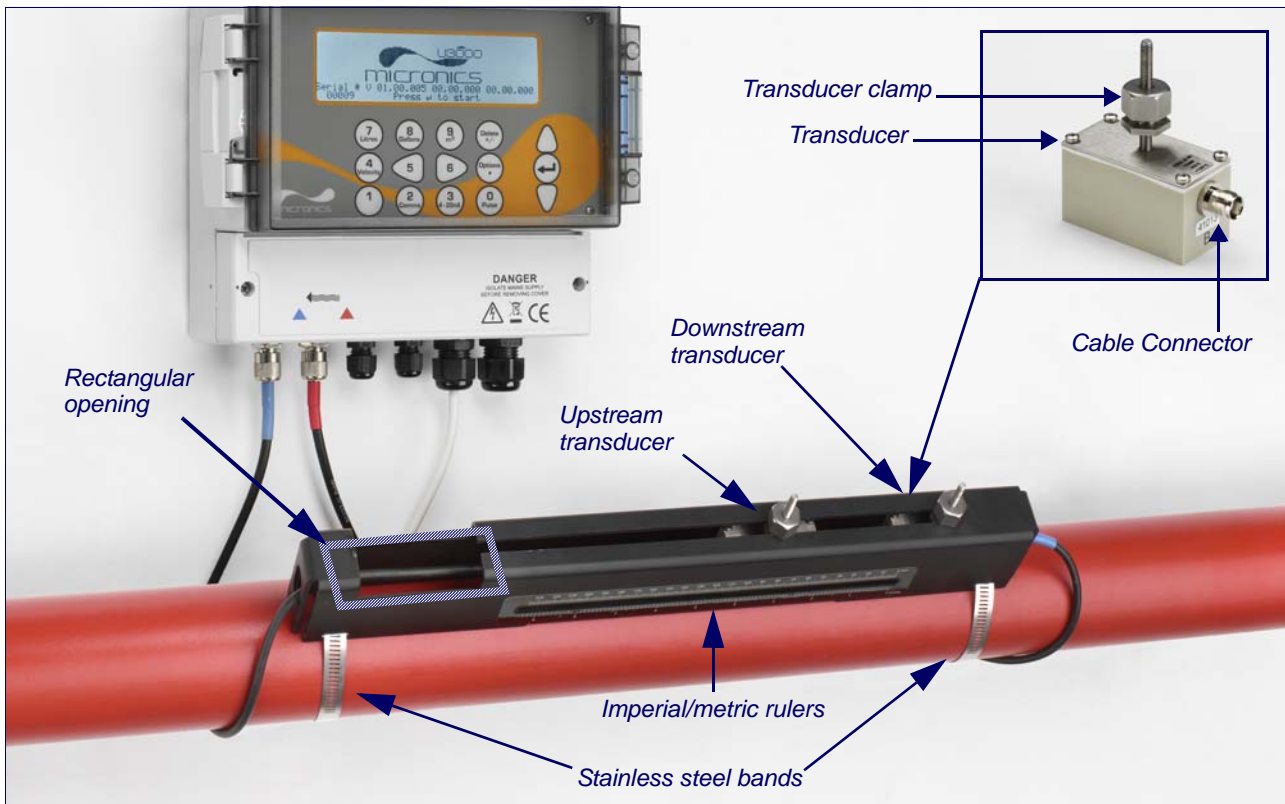

Figure 2.5 Transducer attachment (completed assembly)

Type 'A' or 'B' transducers are attached to the pipe using the adjustable guide rail assembly shown in [Figure 2.5](#). The guide rail itself is secured to the pipe using two wrap-around steel bands. For user convenience, an imperial (inches) and metric (millimetres) ruler is attached to the side plate of the guide rail – as shown in [Figure 2.5](#). Once the guide rail assembly is fully assembled the transducers are locked into position by tightening the transducer clamp.

Note: When using the U3000/U4000 in the 'diagonal' mode, or in 'reflex' mode on pipes over 350 mm diameter, two guide rails are required with a transducer mounted in each one – see [Paragraph 2.3.5](#) for diagonal mode details.

2.3.3 Attaching the guide rail to the pipe

1. Position the guide rail horizontally on the pipe at 45° with respect to the top of the pipe and secure it in position using the supplied stainless steel banding, as shown in [Figure 2.6](#).

Note: In the following procedure the guide rail is installed with the rectangular opening facing towards the upstream end of the pipe.



Figure 2.6

2.3.4 Fitting the transducers

1. Tighten each transducer clamp clockwise until it is close to the top of the transducer (Figure 2.7). This is necessary in order to prevent the acoustic couplant touching the pipe when the transducer is initially inserted into the guide rail – as described below.
2. Using the supplied syringe applicator, apply a 3mm bead of acoustic couplant to the base of both transducers (Figure 2.8).

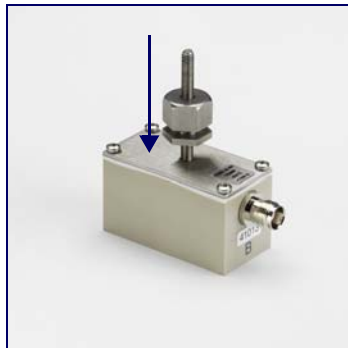

Figure 2.7



Figure 2.8

3. Thread the downstream transducer cable (blue) through the right-hand end of the guide rail and up through the rectangular opening at the top left-hand end of the guide rail, as shown in Figure 2.10.
4. Connect the downstream cable (blue) to one of the transducers.

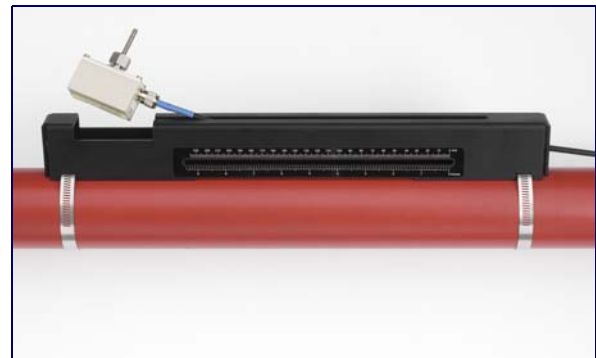

Figure 2.9

Note: When carrying out the following steps handle the transducer assembly with care to avoid smearing the acoustic couplant on the pipe whilst attaching the transducer to the guide rail.

5. Carefully lower the transducer and cable through the rectangular opening until the slots in the side of the transducer clamp align with the edges on the top of the guide rail.

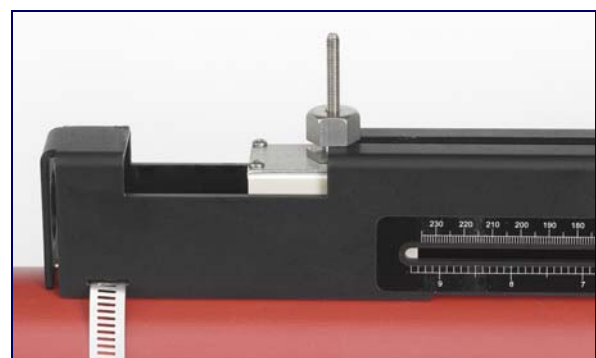

Figure 2.10

- Carefully slide the downstream transducer assembly along the guide rail until the inner face of the transducer is aligned with the '0' mark on the ruler scale ([Figure 2.11](#)).
- Lower the transducer onto the pipe by turning the transducer clamp anti-clockwise until it is 'finger tight' (do not use a spanner).

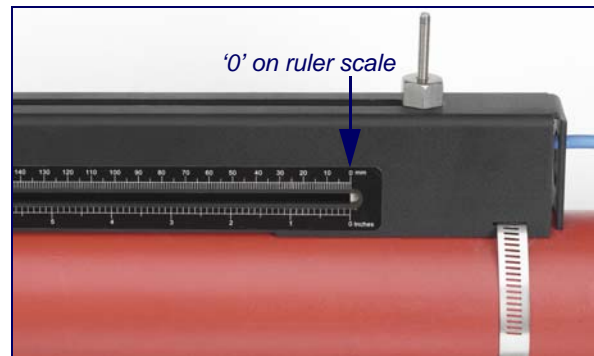

Figure 2.11

- Thread the upstream signal cable (red) through the left-hand end of the mounting rail and connect it to the second transducer ([Figure 2.12](#)).
- Following the method used to insert the downstream transducer, carefully lower the transducer assembly through the rectangular opening until the slots in the side of the transducer clamp align with the edges on the top of the guide rail ([Figure 2.10](#)).



Figure 2.12

- Position the upstream transducer so that the inner face of the transducer is set to the required separation distance on the ruler, as shown in [Figure 2.13](#) (50 mm in this example).

Note: The separation distance for a particular application can be found using the 'Quickstart' menu as described in [Paragraph 3.2](#).

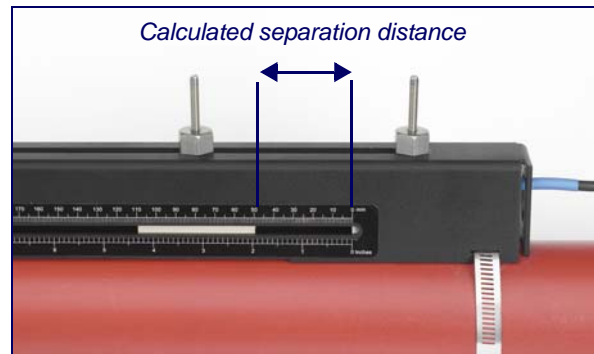

Figure 2.13

- Lower the transducer onto the pipe by turning the transducer clamp anti-clockwise until it is 'finger tight' (do not use a spanner).

[Figure 2.14](#) shows the final position of the transducers when the transducer clamps are fully tightened.

- Ensure the transducer signal cables are correctly connected to the U3000/U4000 instrument – i.e. with the RED cable connected to the upstream transducer connector and the BLUE cable to the downstream transducer connector.

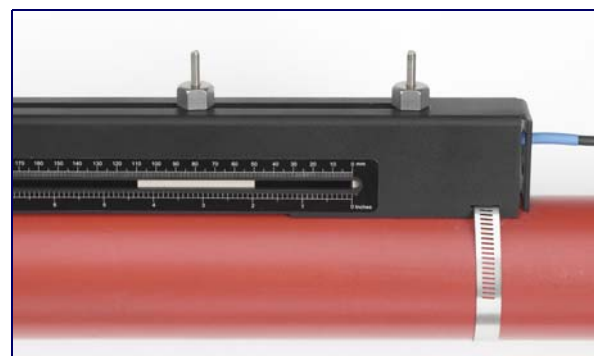

Figure 2.14

13. In some cases, particularly on large pipes using diagonal mode, or pipes with a poor internal condition, the signal from the sensors can be very noisy. In order to improve sensor performance and noise immunity, we recommend that the transducers are earthed, using the supplied cables and attachment hardware, in all installations – as shown in [Figure 2.15](#).

Note: Remove any paint on the pipe in the area of the clamp to achieve a good electrical connection.

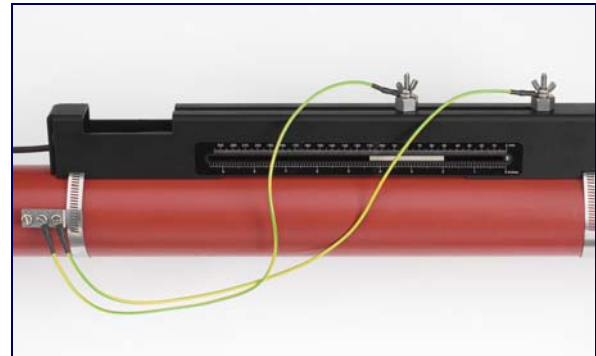

Figure 2.15

2.3.5 Transducer attachment (diagonal mode)

This mode of operation requires two transducer guide rails fitted on opposite sides of the pipe, as shown in [Figure 2.16](#) – notice that the guide rails are still fitted on a 45° axis with respect to the top of the pipe. When used with type 'A' or 'B' transducers the guide rails used are identical to that shown above, and the second guide rail and fixings must be purchased as an option kit.



Key Point: For installations on larger pipes (in the range 2000mm - 5000mm O.D.) it is necessary to use the type 'D' transducer kit which contains the transducers together with their particular mounting rails and fitting instructions. This will have been supplied with the electronics assembly that is configured to work with these larger pipes.

When installing the equipment to operate in the diagonal mode the method of securing the transducers to the guide rails and connecting them to the U3000/U4000 instrument is identical to that described above for the reflex mode. The major difference is that you have to physically mark out the required position of the transducers on the pipe in order to determine where to attach the transducer guide rails.

1. Obtain and note the required separation distance between the transducers using the 'Quickstart' menu as described in [Paragraph 3.2](#).
2. Using whatever means available, mark a reference line around the circumference of the pipe approximately where the upstream transducer is to be fitted – line 'A' in [Figure 2.16](#).
3. On line 'A', mark a position, point 'X', on an axis of approximately 45° from the top of the pipe and draw a one metre long line ('B') perpendicular to 'A' and parallel to the pipe axis.
4. On line A, mark a position, point 'Y', 180° opposite point 'X'.

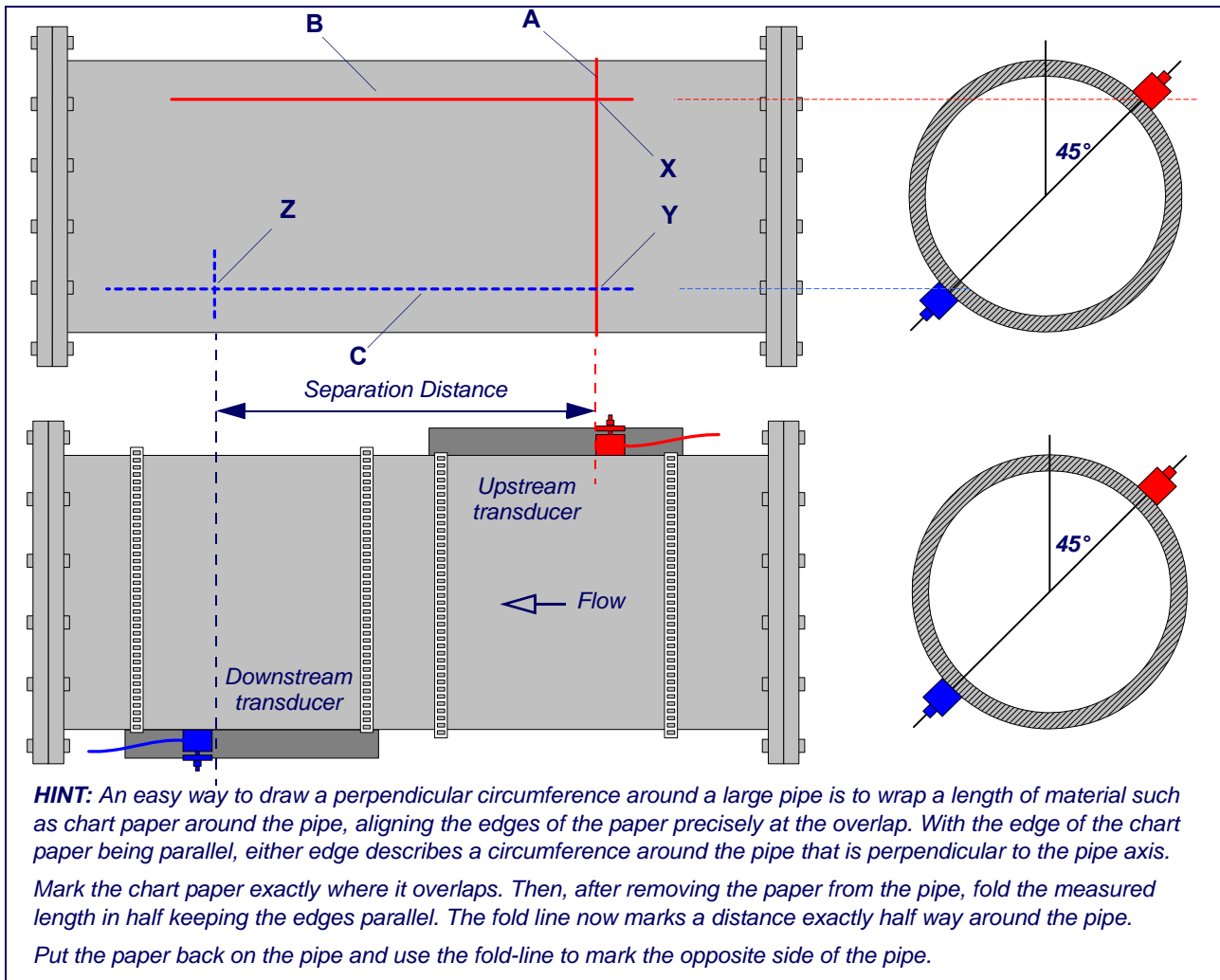

Figure 2.16 Transducer mounting for diagonal mode of operation

5. From point 'Y', draw a one metre long line ('C') perpendicular to 'A' and parallel to the pipe axis. This is shown as a dashed line in [Figure 2.16](#) as it is on the rear of the pipe.
6. Mark a position, point 'Z', on line 'C' which is equal to the transducer separation distance (noted in step 1) from point 'Y'.
7. Position and attach the upstream guide rail to the pipe such that line 'B' runs centrally along the length of the guide rail and point 'X' is within the transducer attachment part of the guide.
8. Fit the upstream transducer (red cable) to the guide rail as described in [Paragraph 2.3.4](#) such that the leading face of the transducer aligns with line 'A'.
9. Position and attach the downstream guide rail to the pipe such that line 'C' runs centrally along the length of the guide rail and point 'Z' is within the transducer attachment part of the guide.
10. Fit the downstream transducer (blue cable) to the guide rail as described in [Paragraph 2.3.4](#) such that the leading face of the transducer aligns with point 'Z'.
11. Connect the transducer cables to the U3000/U4000 instrument.

2.4 Installing the USB Virtual Com. Port (U4000 only)

The USB connection requires a virtual com port to be installed on the computer. The necessary driver can be provided by Micronics or downloaded from <http://www.ftdichip.com/Drivers/VCP.htm>.

1. Access the above url and download the driver for your particular operating system. The download takes the form of a zip file.
2. Extract all the files from the zip file into a folder and note its location (e.g. Desktop\USBDriver).
3. Switch ON the U4000 instrument and connect it to the USB port on the PC.
4. A “New device found” message will appear and ask you for the location of the software installation files for the new device.
5. Use the Browse button to select the path to the unzipped driver files and then click OK.
6. Follow the on-screen instructions to install the driver.
7. At the end of the driver installation routine you must carry out a minor configuration change to the newly installed virtual com port. The way in which you gain access to the com port set-up window will vary depending on your operating system. The following example applies to Windows XP.
8. Select Control Panel\System to open the SYSTEM PROPERTIES window.
9. Click the Device Manager button to open the DEVICE MANAGER window.
10. Scroll down to the Ports region and you will find the new FDTI port installed (e.g. USB Serial Port with a high port number).
11. Right-click on the com port and select Properties.
12. From the PROPERTIES window select the Port Settings tab then click the Advanced button. The ADVANCED SETTINGS window should open similar to that shown below.

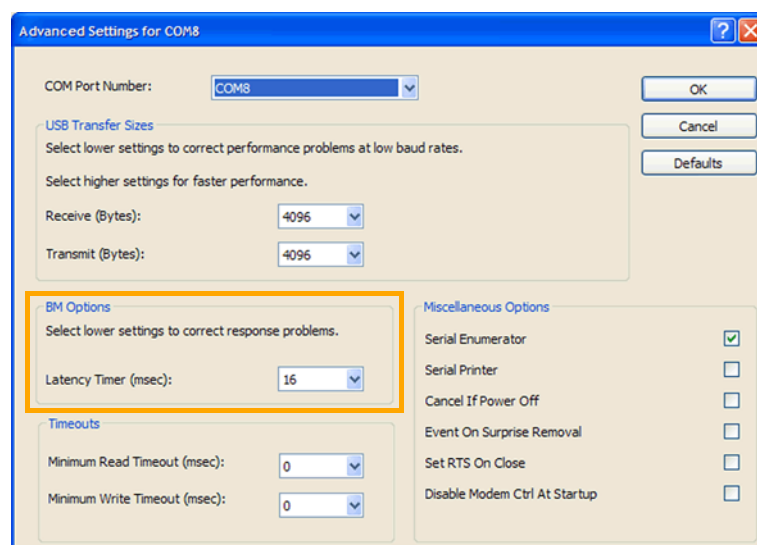
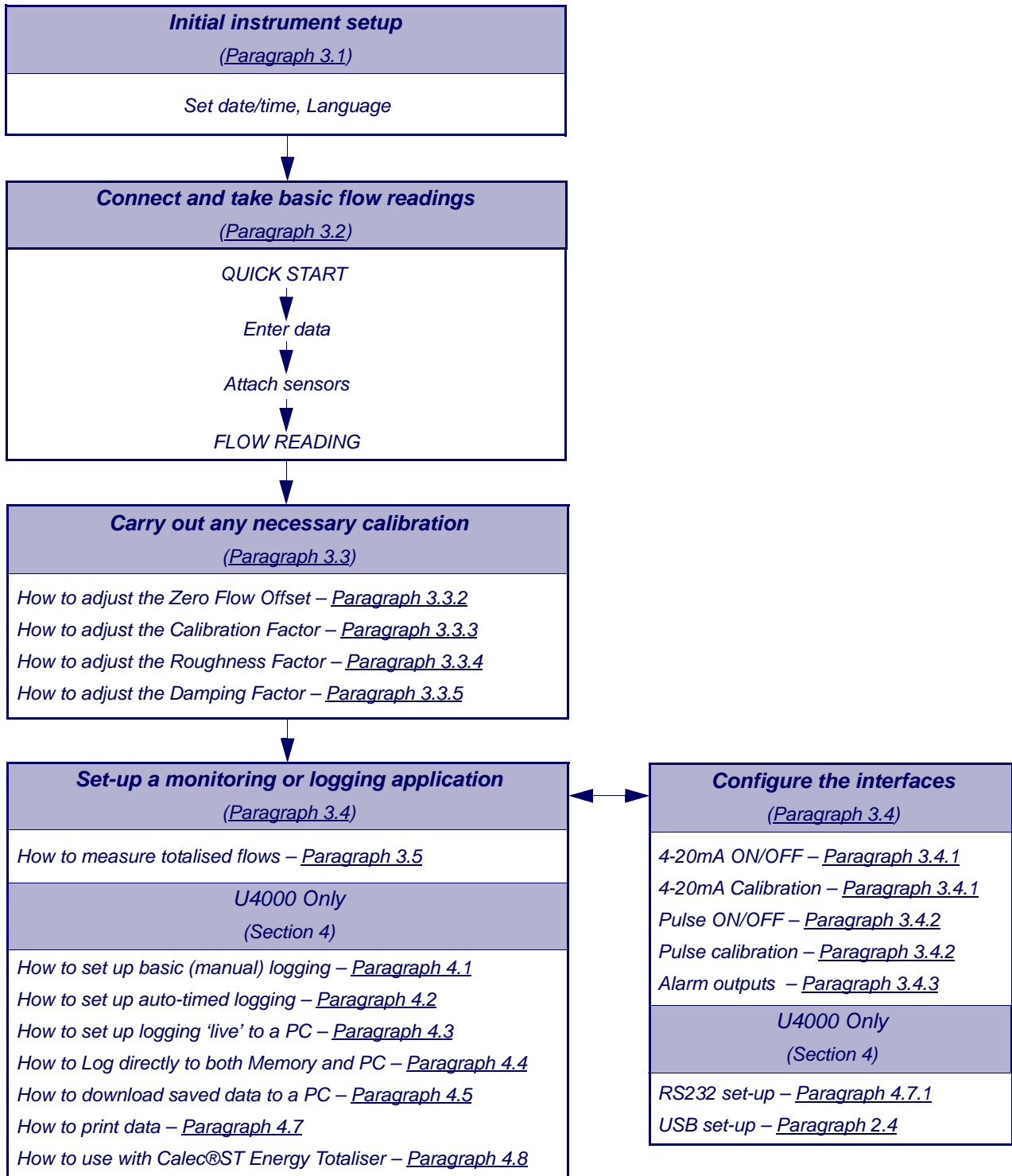

Figure 2.17 Com. Port configuration

13. In the BM Options area change the Latency Timer value from 16 msec (default) to 1 msec.
14. Select OK to implement the change, and then close the remaining windows that were opened.
15. Your computer should now be able to communicate with the U4000 instrument via the USB port in the same way as any other standard USB device.

3: Operating Procedures



3.1 Setting-up the Instrument

The procedures outlined below apply to both the U3000 and U4000, unless otherwise indicated.



Key Point: When the instrument used for the first time the operator has free access to all the set-up and operating menus until the instrument is put into FLOW READING operation, where-upon all the menus become password protected (see Page 24).

3.1.1 Using the instrument for the first time

Initial user language selection

The first time you power-up the instrument you will be asked to select a user language. The selected language will then be the default when the instrument is next used. If you want to change the language when the instrument is in use, see below.

1. On initial power-up, the start-up screen will be displayed for 5 seconds, showing the instrument's serial number and software revision.
2. After 5 seconds, the available language list will be displayed.
3. Select the required language and press ENTER.
4. The instrument will display the MAIN MENU.



The MAIN MENU screen

The MAIN MENU screen is at the top of the menu hierarchy and is the starting point for all the operations described in this chapter. Under normal operating conditions this screen is accessed from the FLOW READING screen by pressing the ENTER key.

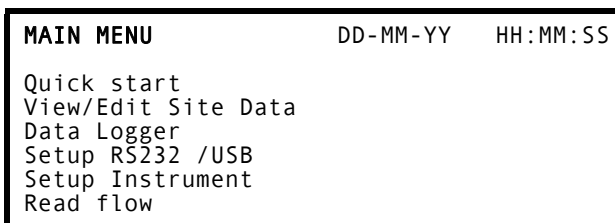

Setting the date & time (*U4000 only)

5. Select Setup Instrument from the MAIN MENU and press ENTER. The SETUP INSTRUMENT screen should now be displayed.
6. Select Set Date & Time and press ENTER.
7. A flashing cursor should appear under the first date number. Enter the date sequence in dd-mm-yy order then press ENTER.
8. Repeat this action to set the time.
9. Select Exit then press ENTER to return to the MAIN MENU.

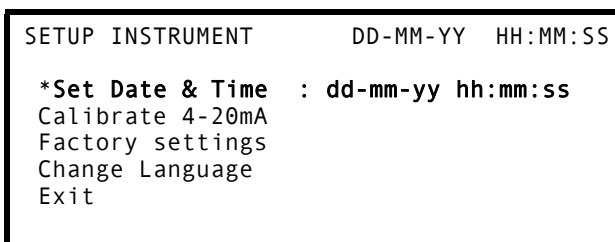

Note: If you make a mistake when entering the data press the Delete key to move the cursor back to the number you wish to change, then continue. If you enter an invalid number an 'ERR:Invalid Date or Time!' error message is displayed on the second line of the screen. If this occurs repeat the set date/time procedure.

Note: *On the U3000 model the Set Date & Time option is not available and the Date and Time display is replaced with a flashing asterisk.

3.1.2 Changing the user language

If you want to change the user language at any time after the instrument has been put into operation:

1. Select Setup Instrument from the MAIN MENU then press ENTER.
2. Select Change Language from the SETUP INSTRUMENT screen then press ENTER.
3. Select the required language from the list provided and press ENTER.
4. The instrument returns to the MAIN MENU.

```

SETUP INSTRUMENT          DD-MM-YY  HH:MM:SS

Set Date & Time   : dd-mm-yy hh:mm:ss
Calibrate 4-20mA
Factory settings
Change Language
Exit
  
```

3.1.3 Changing the date and time (*U4000 only)

The correct date and time should have been set when the instrument was initially put into service. To update the date/time parameters:

1. Set the required Date & Time as described in [Paragraph 3.1.1](#).

```

SETUP INSTRUMENT          DD-MM-YY  HH:MM:SS

Set Date & Time   : dd-mm-yy hh:mm:ss
Calibrate 4-20mA
Factory settings
Change Language
Exit
  
```

3.2 Using the Quick Start Menu

The Quick Start menu gathers various data for the site to be monitored and returns details of the transducer configuration that must be applied when mounting the transducers on the pipe.

Before you can use the U3000/U4000 system you need to obtain the following details – this information is required when setting up the Quick Start menu:

- The pipe outside diameter.
- The pipe wall thickness and material.
- The pipe lining thickness and material (if any).
- The type of fluid contained in the pipe being monitored.
- The fluid temperature.

Entering the site data

1. Select Quick Start from the MAIN MENU and press ENTER. You will then be presented with a series of screens in which to enter the data mentioned above.
2. Select the dimension units (millimetres or inches) used to measure the pipe, then press ENTER.

```

DIMENSION UNIT          DD-MM-YY  HH:MM:SS

Select the dimension units:

↳ mm
Inches
  
```

3. Enter the pipe outside diameter dimension, then press ENTER.

OUTSIDE DIAMETER	DD-MM-YY	HH:MM:SS
Dimensions:		mm
Pipe outside diameter:		76.00

4. Enter the pipe wall thickness dimension, then press ENTER.

PIPE WALL THICKNESS	DD-MM-YY	HH:MM:SS
Dimensions:		mm
Pipe outside diameter:		76.00
Pipe wall thickness:		1.50

5. If the pipe has a lining, enter the lining thickness.
If nothing is entered the instrument automatically assumes there is no lining.
6. Press ENTER to continue.

PIPE LINING THICKNESS	DD-MM-YY	HH:MM:SS
Dimensions:		mm
Pipe outside diameter:		76.00
Pipe wall thickness:		1.50
Pipe lining thickness:		0.0

7. Select the pipe wall material from the list provided, then press ENTER.

If the material is not listed select Other and enter the propagation rate of the pipe wall material in metres/sec. Contact Micronics if this is not known.

PIPE WALL MATERIAL	DD-MM-YY	HH:MM:SS
Select pipe wall material		
Mild Steel		
S' less Steel 316		
S' less Steel 303		
Plastic		
Cast Iron		
Ductile Iron		
Copper		
Brass		
Concrete		
Glass		
Other (m/s)		

8. If a lining thickness value was entered earlier, this screen is displayed to request that you enter the lining material type. If no lining thickness was entered this screen will be bypassed.
9. Select the lining material from the list provided then press ENTER.

If the material is not listed select Other and enter the propagation rate of the lining material in metres/sec. Contact Micronics if this is not known

PIPE LINING MATERIAL	DD-MM-YY	HH:MM:SS
Select pipe lining material		
Steel		
Rubber		
Glass		
Epoxy		
Concrete		
Other (m/s)		

10. Select the fluid type from the list provided and press ENTER.

If the liquid is not listed select Other and enter a propagation rate in metres/second. Contact Micronics if this is not known

```

FLUID TYPE                DD-MM-YY  HH:MM:SS
Select fluid type
Water
Glycol/water 50%
Glycol/water 30%
Lubricating oil
-----
Diesel
Freon
Other (m/s) --
    
```

11. If you need to alter the fluid temperature from that shown select either °C or °F with the cursor and press the ENTER key.
12. Enter the new temperature value and press the ENTER key.
13. The new temperature should now be indicated in both °C and °F.
14. Select Continue.. and press ENTER.

```

FLUID TEMPERATURE        DD-MM-YY  HH:MM:SS
Enter Fluid Temperature
°C: 25.00
°F: 77.00
Continue..
    
```

15. The SENSOR SEPARATION screen now displays a summary of the entered parameters and informs you of the type of sensor to be used, the mode of operation and the distance to set up between the sensors.
In this example it recommends type A-ST (A standard) sensors operating in the 'Reflex' mode spaced at 44.64mm apart. Take a note of these details

```

SENSOR SEPARATION        DD-MM-YY  HH:MM:SS
Site      : Quickstart
Pipe      : 76.00 mm
Wall      : 1.50
Sensors   : A-ST      Reflex
Temperature : 25.00°C 77.00°F
Set sensor separation to 44.64 mm
Press ← to continue, Δ▽ to select sens.
    
```



Key Point: The above example shows the spacing required using a standard type 'A' probe set (A-ST), as supplied with the model U3000/U4000A.

Selecting the operating mode

On large pipes using either type 'B' or 'D' sensors it may be necessary to use the 'Diagonal' mode of operation rather than the 'Reflex' mode – due to signal strength or sensor location. The system will automatically select 'Reflex' mode if it is valid, but the mode can be changed using the following steps.

16. When in the SENSOR SEPARATION screen press either the Up or Down arrow keys. This will display the SENSOR SELECTION menu.
17. Scroll down to Sensor mode and press ENTER.
18. Scroll to the required mode and press ENTER.
19. Select Exit and press ENTER, to return to the SENSOR SEPARATION screen.
20. The correct sensor separation distance for the selected mode will now be displayed.

Note: Do not press ENTER (to continue with the operating procedure) until the transducers are fitted and connected to the instrument.

Password Control

After data has been entered for the first time, the U3000/U4000 password control feature is 'enabled' when you exit from Quick start to the FLOW READING screen. This prevents unauthorised tampering of the set-up data. Once 'enabled', a password control box is displayed if any key is pressed and you must then enter 71360 to 'disable' the password control and gain access to any of the menus.

Note: Once disabled, the password control feature is re-enabled if no keys are pressed for five minutes.

Attaching and connecting the transducers

21. Fit the designated sensors to the pipe using the guide rail as described in [Paragraph 2.3.2](#). The separation distance must be set to within $\pm 0.5\text{mm}$.

Taking a flow reading

22. Once the transducers have been fitted and connected press the ENTER key twice.

23. This will take you from the SENSOR SEPARATION screen to the FLOW READING screen via the signal-checking screen (shown here).

```
Please wait..
Checking signals
```

```
*****
*
*****
```

24. Check that the indicated signal strength on the left of the screen shows at least 2 bars (ideally 3 or 4). If less than 2 bars are shown it indicates there could be a problem with the transducer spacing, alignment or connections; or an application problem.

```
FLOW READING          DD-MM-YY  HH:MM:SS
                        Qxx.xx%
Signal                0.000      l/min
+Total: 0.00          litres
-Total: 0.00          litres
```

25. Qxx.xx% indicates the signal quality and should have a value of 60% or greater.

Flow monitoring

The FLOW READING screen is the one most used during normal monitoring operation. It shows the instantaneous fluid flow together with totalised values (when enabled). In this mode you can select the flow rate measurement units by pressing keys 7 (litres), 8 (Gallons, Barrels) or 9 (m^3), or change the display to show velocity by pressing key 4.

If the flow reading exceeds a value of ± 9999 in the current units then a *10 multiplier will be displayed above the units and the value displayed will be a tenth of the actual value. Similarly a * 100 and *1000 may be displayed on very large flow rates.

There are limitations on the use of these larger flow values with regards to logging of data and setting the current and pulse outputs. If the flow reading is less than $32000 \text{ m}^3/\text{hour}$ then the value can be logged and downloaded via Portagraph III.

Once a valid flow reading is obtained, if the pipe conditions change (such that the flow reading is lost) then the system will automatically rescan to re-establish a stable flow reading. It is important that the instrument is left with the FLOW READING screen on the display because the automatic rescan is disabled if any of the other screens that can be reached from the FLOW READING screen are being displayed.

Note: There will be a delay in the keyboard response if a rescan is in progress when a key is pressed.

3.3 Instrument Calibration

The instrument is fully calibrated before it leaves the factory; however the following adjustments are provided to allow you to further 'fine tune' your instrument to suit local conditions and application where necessary. Apart from the zero flow offset adjustment, these are normally carried out only where the instrument is to be used at a permanent, or semi-permanent, location.

3.3.1 Adjusting the zero cut-off

This adjustment allows you to set a minimum flow rate (m/s) below which the instrument will indicate '0'. The default setting is 0.1 m/s but you may adjust this value if required.

1. With the instrument operating in FLOW READING mode, press the Options key to access the FLOW READING OPTIONS menu shown (password required).
2. Select Zero Cutoff (m/s) and press ENTER.
3. Enter the value for the Zero Cutoff (e.g. 0.06 m/s) then press ENTER.
4. Scroll down to select Exit and press ENTER to return to the FLOW READING screen.

FLOW READING OPTION	DD-MM-YY	HH:MM:SS
Data review		
Zero Cutoff (m/s)	:	0.100
Set zero flow (m/s)	:	0.100
Damping (secs)	:	10
Totaliser	:	Run
Reset +Total		

3.3.2 Adjusting the set zero flow offset

The U4000 instrument operates by comparing the time taken to send an ultrasonic signal between two transducers in either direction. A Set zero flow offset adjustment is provided to compensate for any inherent differences between the two sensors, noise pick-up, internal pipe conditions etc. It can be used to 'zero' the flow indication under no-flow conditions.



Key Point: If you have adjusted the Zero Cutoff point to anywhere above '0' you must reset it to '0' before you can observe and adjust the Set zero flow offset, as its value is very small. Once the Set zero flow offset has been cancelled you can then reapply the Zero Cutoff if required.

1. Stop the liquid flow.
2. With the instrument in FLOW READING mode press the Velocity function key and observe the reading (m/s). Any reading other than 0.000 indicates an offset error and in practice this will typically be in the range ± 0.005 m/s (possibly higher on smaller diameter pipes). If a greater figure is shown it is worth cancelling the offset to obtain a more accurate result. Continue as follows:
3. Press the Options key to access the FLOW READING OPTION screen shown.
4. Select Set zero flow (m/s) and press ENTER.
5. Press ENTER on the subsequent screen to accept the change, which will return you to the screen shown.
6. Scroll down to select Exit and press ENTER to return to the FLOW READING screen.

FLOW READING OPTION	DD-MM-YY	HH:MM:SS
Data review		
Zero Cutoff (m/s)	:	0.010
Set zero flow (m/s)	:	0.000
Damping (secs)	:	10
Totaliser	:	Run
Reset +Total		



Key Point: In order to cancel any applied offset you must read the flow via Quick Start. Any value that you trim-out using the offset adjustment will be added/subtracted from the flow reading across the whole range.

3.3.3 Adjusting the calibration factor



Key Point: USE THIS FACILITY WITH CARE & ONLY WHERE NECESSARY

The instrument is fully calibrated before leaving the factory and under normal circumstances does not require further calibration when used on site.

This facility can be used to correct the flow indication where unavoidable errors occur due to the lack of a straight pipe or where the sensors are forced to be fitted close to the pipe-end, valve, junction etc.

Any adjustment must be made using a reference flowmeter fitted in the system.

With the system running:

1. Stop (Stall) the totaliser facility and zero it ([Paragraph 3.5](#)).
2. Run the totaliser to measure the total flow over a 30-60 minute period, and note the total flow indicated by the reference flow meter over the same period.
3. Calculate the % error between the U3000/U4000 instrument and reference meters. If the error is greater than $\pm 1\%$ calibrate the U3000/U4000 as detailed below.
4. Press the Options key to access the FLOW READING OPTION screen shown.
5. Scroll down and select Calibration factor then press ENTER.
6. Change the calibration factor according to the error calculated in step 3. For example, if the instrument was reading 1% high then increase the Calibration factor value by 0.010. Conversely, if the reading is 1% low then decrease the calibration factor to 0.990.
7. Press ENTER to apply the change.
8. Select Roughness factor or Exit as required and press ENTER.

FLOW READING OPTION	DD-MM-YY	HH:MM:SS
Data review		
Zero Cutoff (m/s)	:	0.010
Set zero flow (m/s)	:	0.000
Damping (secs)	:	10
Totaliser	:	Run
Reset +Total		
Reset -Total		
Calibration factor	:	1.000
Roughness factor	:	0.010
Alarm Settings	:	
Max Pulse Freq (Hz)	:	10.00
Flow at Max Frequency	:	200.00
Calculated Pulse Value:		2.00
Diagnostics		
Select Totals	:	+Total
Chiller Delay	:	0
Chiller Options	:	Off
Exit		

3.3.4 Adjusting the roughness factor

The roughness factor compensates for the condition of the internal pipe wall, as a rough surface will cause turbulence and affects the flow profile of the liquid. In most situations it is not possible to inspect the pipe internally and the true condition is not known. In these circumstances experience has shown that the following values can be used:

Pipe Material	Roughness Factor	Pipe Material	Roughness Factor
Non ferrous metal <ul style="list-style-type: none"> • Glass • Plastics • Light metal 	0.01	Welded steel pipes, new: <ul style="list-style-type: none"> • Long usage, cleaned • Lightly and evenly rusted • Heavily encrusted 	0.1
Drawn steel pipes: <ul style="list-style-type: none"> • Fine planed, polished surface. • Plane surface • Rough planed surface 	0.01	Cast iron pipes: <ul style="list-style-type: none"> • Bitumen lining • New, without lining • Rusted / Encrusted 	1.0

The increase in the roughness factor has the effect of reducing the measured flow rate, compensating for the drag caused by the rougher internal surface.

With the system running in FLOW READING mode:

1. Press the Options key to access the FLOW READING OPTION screen shown.
2. Scroll down and select Roughness factor then press ENTER.
3. Change the roughness factor according to the pipe material and condition as described above.
4. Press ENTER to apply the change.

FLOW READING OPTION	DD-MM-YY	HH:MM:SS
Data review		
Zero Cutoff (m/s)	:	0.010
Set zero flow (m/s)	:	0.000
Damping (secs)	:	10
Totaliser	:	Run
Reset +Total		
Reset -Total		
Calibration factor	:	1.000
Roughness factor	:	0.010
Alarm Settings	:	
Max Pulse Freq (Hz)	:	10.00
Flow at Max Frequency	:	200.00
Calculated Pulse Value:		2.00
Diagnostics		
Select Totals	:	+Total
Chiller Delay	:	0
Chiller Options	:	Off
Exit		

3.3.5 Adjusting the damping factor

By averaging-out the flow rate over several seconds, the Damping factor can be used to smooth out rapid changes in flow rate to prevent wild fluctuations in the displayed flow value. It has a range of 1 to 50 seconds, with a default setting of 10. With the system running in FLOW READING mode:

1. Press the Options key to access the FLOW READING OPTION screen shown.
2. Scroll down and select Damping (secs) and press ENTER. This will open the DAMPING OPTION screen.

FLOW READING OPTION	DD-MM-YY	HH:MM:SS
Data review		
Zero Cutoff (m/s)	:	0.010
Set zero flow (m/s)	:	0.000
Damping (secs)	:	10
Totaliser	:	Run
Reset +Total		
Reset -Total		
Calibration factor	:	1.000
Roughness factor	:	0.010
Alarm Settings	:	
Max Pulse Freq (Hz)	:	10.00
Flow at Max Frequency	:	200.00
Calculated Pulse Value:		2.00
Diagnostics		
Select Totals	:	+Total
Chiller Delay	:	0
Chiller Options	:	Off
Exit		

3. Select the value of the Damping factor as required to remove any unwanted display fluctuations. Increasing the value applies a greater smoothing affect.
4. Press ENTER to apply the change.

DAMPING OPTION	DD-MM-YY	HH:MM:SS
1 second		
10 seconds		
15 seconds		
20 seconds		
30 seconds		
50 seconds		
60 seconds		
120 seconds		
240 seconds		



Key Point: If the damping factor is set too high the value displayed may appear stable but might exhibit large step changes when the value is updated.

3.4 Outputs

Both the U3000 and U4000 have configurable Current, Pulse and Alarm outputs.

3.4.1 Current output

Note: Where long cable runs are necessary, or noise pickup is causing unstable flow readings, the use of two core screened cable, such as BELDEN 9501 060U500, or similar, is recommended for use with the 4-20mA current output. The cable screen should be connected to the RS232 GND terminal.

How to turn the 4-20mA output OFF/ON

1. With the instrument operating in the FLOW READING mode, press the 4-20mA function key. This will access the 4-20mA OUTPUT screen.
2. The ON/OFF status of the 4-20mA output is shown on line 2 of the display.
3. To change the ON/OFF status select Output Range and press ENTER
4. Select Off, to turn OFF the 4-20mA Output or select one of the output ranges to turn it ON.
5. Press ENTER to return to the 4-20mA OUTPUT screen

4-20 mA OUTPUT	DD-MM-YY	HH:MM:SS
4-20 mA O/P is ON		
mA Output Reading	:	0.00
Output Range	:	4-20
Units	:	l/min
Flow at max. output	:	0.00
Flow at min. output	:	0.00
Output mA for error	:	22.00
Exit		

4-20 mA OUTPUT	DD-MM-YY	HH:MM:SS
Off		
4-20mA		
0-20mA		
0-16mA		

4-20mA Signal calibration and ranging



Key Point: The 4-20mA output has been calibrated in the factory and should not require further adjustment. In the rare event that re-calibration is necessary, this procedure should be carried out only by a trained engineer.

This procedure describes how to calibrate the 4-20mA output and 'scale' it to cover a defined flow-rate range.

Signal calibration

6. Select Setup Instrument from the MAIN MENU then press ENTER to access the SETUP INSTRUMENT screen.
7. Select Calibrate 4-20mA. and press ENTER

SETUP INSTRUMENT	DD-MM-YY	HH:MM:SS
Set Date & Time	:	dd-mm-yy hh:mm:ss
Calibrate 4-20mA		
Factory settings		
Change Language		
Exit		

8. Connect a calibrated ammeter to the 4-20mA output and adjust the UP/DOWN Scroll keys (Coarse) and LEFT/RIGHT Scroll keys 5 & 6 (fine) until the output is exactly 4.00mA. The DAC should indicate approximately 8000.
9. Press ENTER when done.
10. With the meter still connected to the 4-20mA output adjust the Scroll keys to obtain an output of exactly 20.00mA. The DAC should indicate approximately 40000.
11. Press ENTER when done.

```

CALIBRATE 4mA          DD-MM-YY  HH:MM:SS

Adjust the output current to 4mA
Use Δ▽ to set, 5/6 to trim

DAC Value:           8000

Press ↵ when done
    
```

```

CALIBRATE 20mA         DD-MM-YY  HH:MM:SS

Adjust the output current to 20mA
Use Δ▽ to set, 5/6 to trim

DAC Value:           40000

Press ↵ when done
    
```

4-20mA Signal scaling

Note: The 4-20mA can be set to represent a particular flow range. It is also possible to enter a negative figure for the minimum output and this would enable a reverse flow to be monitored.

12. With the instrument operating in the FLOW READING mode, press the 4-20mA function key. This will access the 4-20mA OUTPUT screen.
13. Select Flow at max. output and press ENTER, then enter a value of the flow rate that you want to associate with a 20.00mA output.
14. Select Flow at min. output and press ENTER then enter a value of the flow rate that you want to associate with a 4.00mA output. This could be '0'.
15. Select Output mA for error and enter a value (max of about 26mA) that you want the 4-20mA output to produce in the event of an error (e.g. if the flow-rate is outside the set range).
16. Upon completion press ENTER to return to the FLOW READING screen.

```

4-20 mA OUTPUT          DD-MM-YY  HH:MM:SS
4-20 mA O/P is ON
mA Output Reading       :          0.00
Output Range            :          4-20
Units                   :          l/min
Flow at max. output     :          0.00
Flow at min. output     :          0.00
Output mA for error     :          22.00

Exit
    
```

How to convert the measured current to flow rate

Assume the maximum flow rate is F_{max} (l/min) and the minimum flow rate F_{min} is '0' (l/min), as shown.

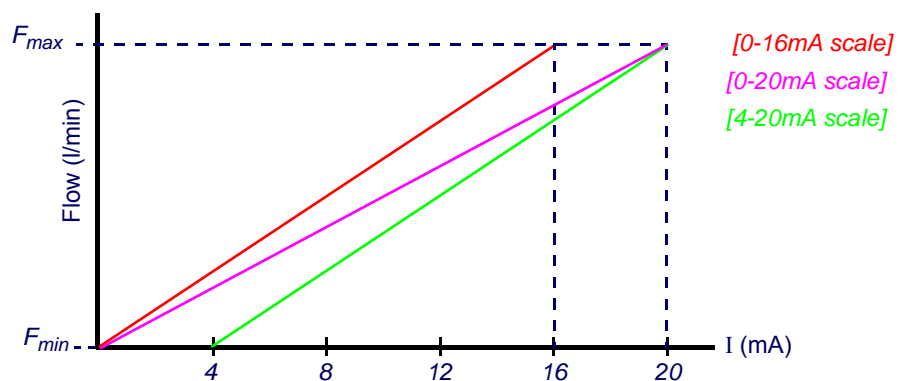

To calculate the flow rate (l/min) for a measured current I(mA) then:

0-20mA	0-16mA	4-20mA
Flow rate = $\frac{I \times (F_{max} - F_{min})}{20} + F_{min}$	Flow rate = $\frac{I \times (F_{max} - F_{min})}{16} + F_{min}$	Flow rate = $\frac{(I - 4) \times (F_{max} - F_{min})}{(16)} + F_{min}$

3.4.2 Pulse output (for Pulse Frequency Output see Page 44)

Pulse output configuration

Two parameters can be configured from the PULSE OUTPUT menu:

- Volume of fluid per pulse.
 - Pulse width.
1. With the instrument operating in the FLOW READING mode, press the Pulse function key to access the PULSE OUTPUT screen.
 2. Ensure that the Output is Off.
 3. Select Vol per pulse and press ENTER.
 4. Enter the required value. (In the example shown, a pulse is produced every 10 litres of flow).

PULSE OUTPUT	DD-MM-YY	HH:MM:SS
Pulse output is ON		
Flow units	:	litres
Output	:	On
Vol per pulse	:	10.00
Pulse width (ms)	:	10
Exit		

Note: The Vol per pulse can only be changed if the Pulse Output is Off.

5. Select a Pulse width (in ms) to suit the particular application – e.g. electro-mechanical counter. Refer to the manufacturer’s data sheet for the minimum pulse width.
6. Select Exit and press ENTER to return to the FLOW READING screen.

How to turn the pulse output OFF/ON

7. With the instrument operating in the FLOW READING mode, press the Pulse function key to access the PULSE OUTPUT menu.
8. Select Output and press ENTER.
9. Select On and press ENTER.
10. A Pulse output is ON message will appear in the second line of the display.
11. Select Exit and press ENTER to return to the FLOW READING screen.

PULSE OUTPUT	DD-MM-YY	HH:MM:SS
Pulse output is ON		
Flow units	:	litres
Output	:	On
Vol per pulse	:	10.00
Pulse width (ms)	:	10
Exit		

3.4.3 Alarm outputs

Both the U3000 and U4000 models contain two programmable alarm outputs that are interfaced by opto-isolated relays. The relay contacts are rated at a 48V (maximum voltage across the open contacts) and 500mA (maximum continuous current through the closed contacts).

The two alarm outputs can be individually configured to operate in one of four modes:

- Activate at a predefined Low or High flow rate.
- Activate when a specified Volume is measured.
- Activate if a signal error is detected – either due to poor signal strength or complete signal loss.
- Alarm Test mode.
- Pulse Frequency output.

Alarm settings selection

1. To access the The ALARM SETTINGS menu select Alarm Settings from the FLOW READING OPTION menu and press ENTER.
2. The ALARM SETTINGS screen should be displayed, as shown below. This screen shows two parameters (Mode and Limit) that can be individually set for Alarm 1 and Alarm 2.

FLOW READING OPTION	DD-MM-YY	HH:MM:SS
Data review		
Zero Cutoff (m/s)	:	0.010
Set zero flow (m/s)	:	0.000
Damping (secs)	:	10
Totaliser	:	Run
Reset +Total		
Reset -Total		
Calibration factor	:	1.000
Roughness factor	:	0.010
Alarm Settings	:	
Max Pulse Freq (Hz)	:	10.00
Flow at Max Frequency	:	200.00
Calculated Pulse Value:		2.00
Diagnostics		
Select Totals	:	+Total
Chiller Delay	:	0
Chiller Options	:	Off
Exit		

Alarm configuration

1. To setup Alarm 1 select Alarm1 Mode and press ENTER. This will access the ALARM1 MODE menu screen (shown below).

ALARM SETTINGS	DD-MM-YY	HH:MM:SS
Alarm1 Mode		
Alarm1 Level	:	<value>
Alarm2 Mode		
Alarm2 Level	:	<value>
Exit		
Alarm1 ON		Alarm2 ON

2. Scroll down the menu to the required alarm operating mode and press ENTER to select.

ALARM1 MODE	DD-MM-YY	HH:MM:SS
Off		
Low		
High		
Volume		
On Flow Error		
Alarm Test		
Frequency		

3. This will return you to the ALARM SETTINGS menu.
4. If the selected mode is Low, High or Volume, select Alarm1 Level, enter an appropriate value and press ENTER to set the alarm operating point (see below).

ALARM SETTINGS	DD-MM-YY	HH:MM:SS
Alarm1 Mode		
Alarm1 Level	:	<value>
Alarm2 Mode		
Alarm2 Level	:	<value>
Exit		
Alarm1 ON		Alarm2 ON

High or Low limit values

If High or Low limits are selected, the value entered in the ALARM SETTINGS menu must be in the range -9999 to +9999. This value is in the units previously selected (e.g. l/min, gal/s). The default value is +9999.

Volume limit values

If VOL limit is selected, the value entered in the ALARM SETTINGS menu must be in the range -3,999,999,999.99 to +3,999,999,999.99. This value will be in the units previous selected (e.g. litres, m3, gals) The default value should be +3,999,999,999.99.

Alarm Test

1. Select Alarm Test and press ENTER in the Alarm1 MODE menu to test that Alarm1 can be activated.
2. Select Alarm Test and press ENTER in the Alarm2 MODE menu to test that Alarm2 can be activated.

Pulse Frequency

When Frequency is selected, a variable frequency pulse proportional to the flow rate can be output at the ALARM 1 or ALARM 2 outputs. When this feature is used, the Max Pulse freq (Hz) and Flow at Max Frequency must be set in the FLOW READING OPTION menu. (Refer to Page 44 for operation with the Calec® ST Energy Totaliser for full details.)

Resetting an alarm

When either Alarm1 or Alarm2 is activated, the appropriate relay will be held in the closed position until:

- The activation condition is removed, or
- The Alarm is reset.

Both Alarm1 and Alarm2 can be reset by using one of the following procedure:

1. Access the The ALARM SETTINGS menu by selecting Alarm Settings from the FLOW READING OPTION menu and press ENTER.
2. The ALARM SETTINGS screen should be displayed, as shown below.

FLOW READING OPTION	DD-MM-YY	HH:MM:SS
Data review		
Zero Cutoff (m/s)	:	0.010
Set zero flow (m/s)	:	0.000
Damping (secs)	:	10
Totaliser	:	Run
Reset +Total		
Reset -Total		
Calibration factor	:	1.000
Roughness factor	:	0.010
Alarm Settings		
Max Pulse Freq (Hz)	:	10.00
Flow at Max Frequency	:	200.00
Calculated Pulse Value:		2.00
Diagnostics		
Select Totals	:	+Total
Chiller Delay	:	0
Chiller Options	:	Off
Exit		

Alarm configuration

1. To reset Alarm 1 select Alarm1 Mode and press ENTER. This will access the ALARM1 MODE menu screen (shown below).

ALARM SETTINGS	DD-MM-YY	HH:MM:SS
Alarm1 Mode		
Alarm1 Limit	:	<value>
Alarm2 Mode		
Alarm2 Limit	:	<value>
Exit		
Alarm1 ON		Alarm2 ON

2. Select **Off** from the menu and press **ENTER**.
3. This should de-activate the alarm.
To re-arm the alarm you must ensure that the activation condition is removed and then reconfigure the Alarm Mode as described above on Page 32.

ALARM1 MODE	DD-MM-YY	HH:MM:SS
Off		
Low		
High		
Volume		
On Flow Error		
Alarm Test		
Frequency		

3.5 How to Measure Totalised Flows (manually)

The basic measurement indicated on the FLOW READING screen is the instantaneous flow rate, which in some applications may vary over a period of time. Average flow rates are therefore often required in order to get a better understanding of an application's true performance. This is simply achieved by noting the total flow over a specific period (for example 30-60 minutes) and then calculating the average flow rate over that period of time.

1. Press the **Options** key to access the FLOW READING OPTION screen shown.
2. If the **Totaliser** is indicating **Run**, select it and change it to **Stall**. Press **ENTER**.
3. Select **Reset +Total** and press **ENTER**.
4. Press **ENTER** on the subsequent screen to accept the reset.
5. Press **ENTER** again to return to the FLOW READING OPTIONS menu.
6. Select **Reset -Total** and press **ENTER**.
7. Press **ENTER** on the subsequent screen to accept the reset.
8. Press **ENTER** again to return to the FLOW READING OPTIONS menu.
9. Note and record the current time.
10. Select **Totaliser** and change it to **Run**. Press **ENTER**.

FLOW READING OPTION	DD-MM-YY	HH:MM:SS
Data review		
Zero Cutoff (m/s)	:	0.010
Set zero flow (m/s)	:	0.000
Damping (secs)	:	10
Totaliser	:	Stall
Reset +Total		

FLOW READING OPTION	DD-MM-YY	HH:MM:SS
Zero Cutoff (m/s)	:	0.00
Set zero flow (m/s)	:	0.00
Damping (secs)	:	10
Totaliser	:	Run
Reset +Total		
Reset -Total		

Note: the totalisers begin to count up as soon as **Totaliser** is set to **Run**.

11. Scroll down and select **Exit** to return to the FLOW READING screen which will now indicate the instantaneous flow together with the totalised flow.

Note that in some installations the measured flow can be in either direction. Where this is the case the upstream flow is shown separately in the **-Total** field.

FLOW READING	DD-MM-YY	HH:MM:SS
Signal 		Qxx.xx%
12.34		l/min
+Total: 300.0		litres
-Total: 0.00		litres

Calculating the average flow

To calculate the average flow wait for the allotted monitoring period to expire then divide the indicated total flow by the time taken. This will give you the average flow in m/s, galls/hour or whatever units you select.

Note that in a bi-directional flow situation you must calculate the difference between the indicated positive and negative flow totals before carrying out the average flow rate calculation.

How to stop the totaliser temporarily

If you want to stop the totaliser temporarily for operational reasons, set the Totaliser option to Stall in the FLOW READING OPTIONS screen as described above. This will stop the totaliser operation without affecting its current values.

3.6 Display of totalisers

1. To change the display of the totalisers select the Select Totals menu item from the FLOW READING OPTION menu.
2. The display of the totals on the FLOW READING screen is controlled by this menu.
3. Select one, both or no totals to be displayed. The default is the display of the +Total.
4. Press the ENTER key.

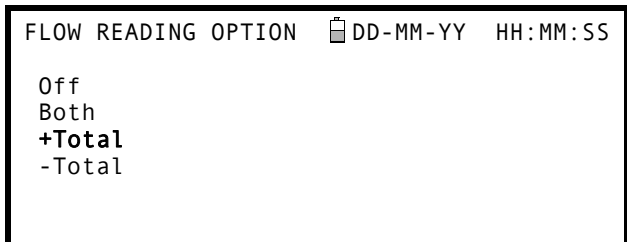

Note: This menu selection only affects the Display of the totaliser. Unless the totalisers are stalled, the recorded volume will still be incremented and the totals will be logged irrespective of the display setting.

3.7 Setting the Chiller Options

When there is a significant change in flow rate in a chiller system the acoustic properties of the fluid can change such that the signal is temporarily lost or a false flow reading is obtained. Under these conditions the normal action of the U3000/U4000 system is to go to a fault state on both the flow reading and the current output, which may be undesirable on a short term loss of signal. This potential problem can be overcome by selecting a suitable setting in the Chiller Options sub-menu and entering an appropriate value for the Chiller Delay option, as follows.

1. Press the Options key to access the FLOW READING OPTION screen shown.
2. Scroll down and select Chiller Options and press ENTER. This will open the CHILLER OPTIONS screen.

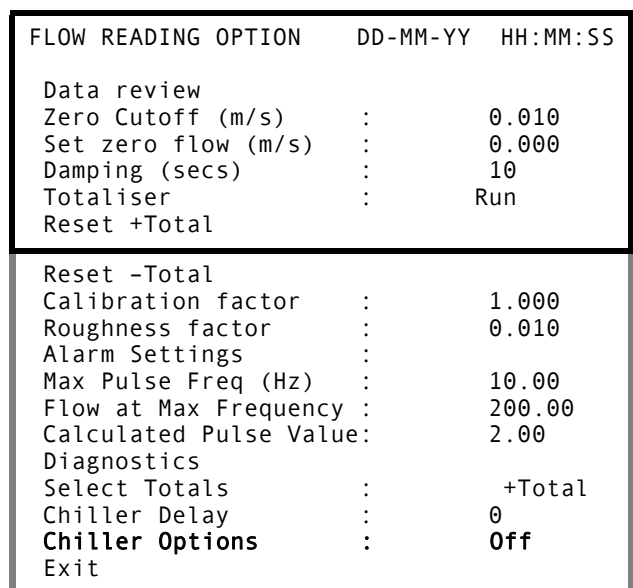

3. Select the required option, as detailed below.
4. Press ENTER to apply the change.

CHILLER OPTIONS	DD-MM-YY	HH:MM:SS
Off		
Zero		
Negative		
Hold		
No Reset		

Off

No change in response to a lost signal. This is the default value.

Zero

Disables the fault condition, and the system's outputs act as if the flow reading has gone to zero.

Negative

A false negative flow reading may be generated as a result of the poor conditions in the pipe; but with this option selected any negative readings are displayed as zero flow.

Hold

With this option selected, the flow reading will remain at the last valid value for a time period set by the Chiller Delay (s). After which time the normal fault condition will occur.

No Reset

Used to prevent the system changing the flow reading setup when the fluid conditions change and then, after a delay when the conditions return to normal, changing back to the original setup. This may reduce the time that the poor conditions affect the performance of the instrument, by not reacting to a short term fault condition.

3.7.1 Setting the Chiller Delay

If a signal fault occurs when the CHILLER OPTION is set to Hold, the selected Chiller Delay determines how long, in seconds, the flow reading is held at the last valid value before it reverts to a fault condition.

1. Press the Options key to access the FLOW READING OPTION screen shown.
2. Scroll down and select Chiller Delay then press ENTER.
3. Using the numerical keypad, enter a Chiller Delay value between 0 (default) and 9999 seconds.
4. Press ENTER to apply the change.
5. The applied Chiller Delay value will now be displayed.

FLOW READING OPTION	DD-MM-YY	HH:MM:SS
Data review		
Zero Cutoff (m/s) :		0.010
Set zero flow (m/s) :		0.000
Damping (secs) :		10
Totaliser :		Run
Reset +Total		
Reset -Total		
Calibration factor :		1.000
Roughness factor :		0.010
Alarm Settings :		
Max Pulse Freq (Hz) :		10.00
Flow at Max Frequency :		200.00
Calculated Pulse Value:		2.00
Diagnostics		
Select Totals :		+Total
Chiller Delay :		0
Chiller Options :		Off
Exit		

4: Data Logging & Communications (U4000)

4.1 How to Set Up the Basic Logging Application to Memory

This procedure shows you how to set up a basic logging session under manual start/stop control.

Logged data is saved to the instrument's memory and can be downloaded to a PC at a later time. Either -Flow Rate or +Flow Rate and \pm Totals can be logged to Memory, RS232 or both. Totals are always logged and can be selectively down loaded after the logging has stopped.



Key Point: To view the totals on the screen and send them to the RS232/USB output as they are logged, you have to select the required option in the Data Logger menu before setting up the flow reading.

Setting up and starting the logging

1. With the U4000 operating in FLOW READING mode, check that the indicated flow units are the same as those you want to appear on the logger output (e.g. l/min).
2. Press the Logger function key to access the REAL TIME LOGGER screen.
3. Select Log data to and choose Memory to store the log to the instrument's internal memory.
4. Select Logging interval and enter the required period (e.g. 10 seconds).
5. Select Clear log if you want to discard any existing logging data.
6. Select START NOW.
7. This screen appears only if a log already exists for the QuickStart site. It allows you to either delete or save the existing log, or cancel the START NOW request.

```
REAL TIME LOGGER      DD-MM-YY  HH:MM:SS
Logging to Memory
Unit                  : l/min
Log name              : Quickstart
Log data to          : Memory
Logging interval     : 10 seconds
Start date & time    : dd-mm-yy hh:mm:ss
Stop date & time     : dd-mm-yy hh:mm:ss
```

```
MM DD HH MM SS
Remaining time       : mm dd hh mm ss
Memory Rollover     : Overwrite
Graph Y axis max.   : 50
View log as text
View log as graph
START NOW
Set Auto start
Clear log
Exit
```

```
ERR:Log not empty    DD-MM-YY  HH:MM:SS
```

```
Press ← to confirm deletion
Press △ to save log and continue
Press ▽ to cancel
```

Monitoring the logged events as a table

1. The VIEW LOG AS TEXT screen displays the log events in date-stamped chronological order.

Press key 5 to go to the top line of logged data or key 6 to go to the bottom line.

2. Press the ENTER key to return to the REAL TIME LOGGER screen. Then select Exit to return to the FLOW READING screen. Logging will continue to take place in the background.

VIEW LOG AS TEXT	DD-MM-YY	HH:MM:SS
Logging to memory		
Log: Quickstart		l/m
Date	Time	Flow
DD-MM-YY	hh:mm:ss	xxx.xx
DD-MM-YY	hh:mm:ss	xxx.xx
DD-MM-YY	hh:mm:ss	xxx.xx
DD-MM-YY	hh:mm:ss	xxx.xx

DD-MM-YY	hh:mm:ss	xxx.xx



Key Point: There can be only one set of logged data per site. If a new data log is started on a site it will clear the existing data.

Monitoring the logged events as a graphic

1. If you want to view the logging progress graphically rather than as text, press the Logger function key to get to the REAL TIME LOGGER screen.
2. Select Graph Y axis max and enter a value slightly greater than the expected maximum flow.
3. Select View log as graph. This will open the VIEW LOG AS GRAPH screen shown below.
4. You can select the data at any point in time by scrolling along the time axis of the graph using the LEFT/RIGHT scroll keys (5 & 6). The data values for the selected point are then shown to the left of the graph. Keep the scroll key pressed for the cursor to move automatically.
5. If you want to change the value of the Y axis to improve the resolution of the graph press the UP/DOWN scroll keys. The maximum values will then increase/decrease as appropriate.
6. To exit the VIEW LOG AS GRAPH screen and return to the REAL TIME LOGGER screen press ENTER.

REAL TIME LOGGER	DD-MM-YY	HH:MM:SS
Logging to Memory		
Unit	:	l/min
Log name	:	Quickstart
Log data to	:	Memory
Logging interval	:	10 seconds
Start date & time	:	dd-mm-yy hh:mm:ss
Stop date & time	:	dd-mm-yy hh:mm:ss
Remaining time	:	MM DD HH MM SS
Memory Rollover	:	mm dd hh mm ss
Graph Y axis max.	:	50
View log as text		
View log as graph		
START NOW		
Set Auto start		
Clear log		
Exit		

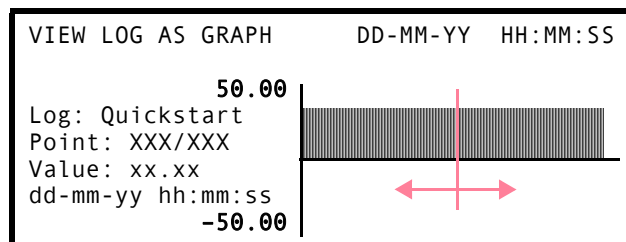

Monitoring the logged events at a later time

If you wish to monitor the logging progress at any time while you are operating in FLOW READING mode without interfering with the logging operation:

1. Press the Logger function key as described above to switch to the REAL TIME LOGGER screen.
2. Select View log as text or View log as graph, as required.



Key Point: To ensure that logging and flow readings continue under all circumstances the display must be returned to the FLOW READING screen.

Stop logging

1. From the FLOW READING screen, press the Logger function key to access the REAL TIME LOGGER screen.
2. Select STOP NOW to cease logging. Note that the START NOW and STOP NOW options toggle depending on which was last selected.
3. Select Exit to return to the FLOW READING screen.
4. Note that the logged data will remain stored in the instrument's memory and can be accessed at any time as described above.

REAL TIME LOGGER	DD-MM-YY HH:MM:SS
Unit	: l/min
Log name	: Quickstart
Log data to	: Memory
Logging interval	: 10 seconds
Start date & time	: dd-mm-yy hh:mm:ss
Stop date & time	: dd-mm-yy hh:mm:ss
MM DD HH MM SS	
Remaining time	: mm dd hh mm ss
Memory Rollover	: Overwrite
Graph Y axis max.	: 50
View log as text	
View log as graph	
STOP NOW	
Set Auto start	
Clear log	
Exit	

4.2 How to Set Up Automatic (Timed) Logging Mode

This procedure shows you how to set up an auto logging session under timed start/stop control. The logged data is saved to the instrument's memory and can be downloaded to a PC at a later time.

Starting point

This procedure assumes that the instrument has been correctly installed and is operating in the FLOW READING mode. Also that the instrument's date and time are correctly set.

Setting up, starting and cancelling auto logging



Key Point: When entering the Start and Stop times in this procedure, you must enter '00' in the seconds field rather than leave it blank, otherwise an error message is displayed.

1. With the U4000 instrument operating in FLOW READING mode, check that the indicated flow units are the same as those you want to appear on the logger output (e.g. l/min).
2. Press the Logger function key to access the REAL TIME LOGGER screen.
3. Select Log data to and choose Memory. This will store the log to the internal memory.
4. Select Logging interval and enter the required period (e.g. 10 seconds).
5. Select Start date & time and enter the date and time you wish logging to commence. Note this must be in the future.
6. Select Stop date & time and enter the date and time you wish logging to cease. Note this must be later than the start time.
7. If the instrument is to be left unattended for a long logging period of time the logged data could possibly fill the memory. Select the Memory Rollover option to either

REAL TIME LOGGER	DD-MM-YY HH:MM:SS
Logging to Memory	
Unit	: l/min
Log name	: Quickstart
Log data to	: Memory
Logging interval	: 10 seconds
Start date & time	: dd-mm-yy hh:mm:ss
Stop date & time	: dd-mm-yy hh:mm:ss
MM DD HH MM SS	
Remaining time	: mm dd hh mm ss
Memory Rollover	: Overwrite
Graph Y axis max.	: 50
View log as text	
View log as graph	
START NOW	
Set Auto start	
Clear log	
Exit	

Stop or Overwrite. This determines what happens to the stored data if the memory becomes full. Similarly, select Clear Log if you want to ensure that maximum memory is available.

Note: if you select to clear all logs you will lose all the currently held log data.

8. Select Set auto start. This enables the auto logging application.

If Set Auto start is enabled with valid start and stop times then this entry will change to Cancel Auto start.

9. To cancel the automatic logging session before it commences, click the Cancel Auto Start.
10. Select Exit to return to the FLOW READING screen.

REAL TIME LOGGER	DD-MM-YY HH:MM:SS
Logging to Memory	
Unit	: l/min
Log name	: Quickstart
Log data to	: Memory
Logging interval	: 10 seconds
Start date & time	: dd-mm-yy hh:mm:ss
Stop date & time	: dd-mm-yy hh:mm:ss
	MM DD HH MM SS
Remaining time	: mm dd hh mm ss
Memory Rollover	: Overwrite
Graph Y axis max.	: 50
View log as text	
View log as graph	
START NOW	
Cancel Auto Start	
Clear log	
Exit	

Monitoring the logged events

This is described in detail in [Paragraph 4.1](#). If you wish to view the logging progress at any time while you are operating in FLOW READING mode, without interfering with the logging operation:

1. Press the Logger function key as described above to access the REAL TIME LOGGER screen.
2. Select View log as text or View log as graph, as required.

Manually stopping the auto logging session

1. The logging session will stop automatically at the programmed Stop date & time.
2. If you wish to manually stop logging earlier than programmed, press the Logger function key to access the REAL TIME LOGGER screen then select STOP NOW to cease logging.
3. Select Exit to return to the FLOW READING screen.

The logged data will remain stored in the instrument's memory and can be viewed at any time as described above.

REAL TIME LOGGER	DD-MM-YY HH:MM:SS
Unit	: l/min
Log name	: Quickstart
Log data to	: Memory
Logging interval	: 10 seconds
Start date & time	: dd-mm-yy hh:mm:ss
Stop date & time	: dd-mm-yy hh:mm:ss
	MM DD HH MM SS
Remaining time	: mm dd hh mm ss
Memory Rollover	: Overwrite
Graph Y axis max.	: 50
View log as text	
View log as graph	
STOP NOW	
Set Auto start	
Clear log	
Exit	

4.3 How to Log Directly to a PC

Instead of logging to the instrument's internal memory, real time data logging to a PC can be accomplished as follows:

1. With the U4000 instrument operating in FLOW READING mode, press the Logger function key to access the REAL TIME LOGGER screen.
2. Select Log data to and press ENTER.
3. Select RS232 and press ENTER.
4. If necessary, change the Logging interval.
5. Select START NOW and press ENTER. Real time data logging to the PC will now commence at the specified logging interval.
6. To STOP logging to the PC, select STOP NOW from the REAL TIME LOGGER menu and press ENTER.

REAL TIME LOGGER	DD-MM-YY HH:MM:SS
Unit	: l/min
Log name	: Quickstart
Log data to	: RS232
Logging interval	: 10 seconds
Start date & time	: dd-mm-yy hh:mm:ss
Stop date & time	: dd-mm-yy hh:mm:ss
Remaining time	MM DD HH MM SS
Memory Rollover	: mm dd hh mm ss
Graph Y axis max.	: 50
View log as text	
View log as graph	
STOP NOW	
Set Auto start	
Clear log	
Exit	

Note: In order for the above procedure to work, the U4000 must be connected to the PC and the RS232/USB link already established.

4.4 How to Log Directly to Both Memory and PC

Logging simultaneously to both the unit's internal memory and to the PC (or Printer) can be set up as follows:

1. From the REAL TIME LOGGER menu, select Log data to and then select Both.
2. Select START NOW to begin the logging session.



Key Point: This will only work if the U4000 is connected to the PC and the RS232 link has already been established. If the RS232 protocol has not been configured you can access the RS232 set-up screen by pressing the Comms button.

4.5 How to Download Logged Data to a PC

This procedure describes how to download stored data to a PC. It assumes that the U4000 is already connected to the PC's serial port and that RS232/USB communication has been established, as described in [Paragraph 4.6](#).

1. Access the MAIN MENU.

Note: If this is done from the FLOW READING screen any logging currently taking place will be terminated.

2. Select View Logged Data from the MAIN MENU.
3. Only two sites are available on the U4000. One non-editable site name (QuickStart) and one editable site name (default EmptySite1). Select Choose from list of sites and select one of these site names to download.

VIEW LOGGED DATA	DD-MM-YY HH:MM:SS
Choose from list of sites	
View log as text	
View log as graph	
Graph Y axis max. :	1.00
Download log	
Clear log	
Select log totals	
Exit	

- The totals are always logged. If you wish to display them when either viewing a log or downloading it to a PC or printer, then use the options in **Select Log Totals**. The default is **Off**. (Portagraph III does not display the totals, even if they are enabled).
- If you want to view the log prior to downloading it you can do so using the **View log as text** or **View log as graph** options.
- When you are ready to begin downloading the log select **Download log**.
- From the **DOWNLOAD LOG** screen select **USB** or **RS232** then select **Send** from the subsequent confirmation screen.
- The selected logged data is now downloaded to the PC.
- Upon completion select **Exit** to return to the **VIEW LOGGED DATA** screen.
- On the **VIEW LOGGED DATA** screen you can now **Clear** the log if required or **Exit** directly back to the **MAIN MENU**.

```
VIEW LOGGED DATA      DD-MM-YY  HH:MM:SS
Off
Both
+Total
-Total
```

```
DOWNLOAD LOG          DD-MM-YY  HH:MM:SS
Select Serial port or printer & press ↵
USB
RS232
Exit
```



Key Point: When using the USB to download data, make sure that the USB driver has been installed and the correct COM port has been set (see [Paragraph 2.4](#)).

4.6 Working with Portagraph III

Micronics Ltd supplies the 'Portagraph III Downloading and Graphing' software to make it easy for the user to downloading logged data to a PC. Logged data can then be downloaded and analysed using the Portagraph III graphing capability, or exported to Microsoft Excel® for more detailed graphing and analysis.

Portagraph III will automatically detect the unit's RS232 configuration (baud rate, data bits, parity, stop bits) so there is no need for the user to specifically set this up.

For full details of Portagraph III operation, refer to the Portagraph III user manual.

4.7 Printing

Logged data can be printed using an RS232-compatible printer.

4.7.1 How to print logged data using the RS232 printer

This procedure shows you how to set up and use the RS232 printer to print logged data.

Setting up an RS232 connection

- Connect the TXD Data, RXD Data and Signal Ground wires from the Printer to the terminal blocks on the U4000.

2. Select Setup RS232 / USB from the MAIN MENU. This will access the SETUP RS232/USB screen shown here.
3. Set the RS232 parameters to comply with those for the printer.

The parameters shown here are for the Seiko DPU-414 Thermal Printer.

SETUP RS232 / USB	DD-MM-YY	HH:MM:SS
Handshaking	:	Xon/Xoff
Baud Rate	:	1200
Data Bits	:	8
Stop Bits	:	1
Parity	:	None
New line	:	CR+LF
Printer test :		
Exit		

4. Ensure that the printer has sufficient paper, is switched ON and ON LINE.
5. To check that the U4000 printer interface is operational, select Printer test from the SETUP RS232/USB menu. If the RS232 interface is working correctly the following message will be printed:

<software revisions>
<unit serial number>

If nothing is printed, check that the RS232 parameter settings are correct for the printer and that the U4000 TxD and RxD signals are compatible with the printer's RS232 interface. A gender changer may be required to swap the TxD and RxD signals.

Printing logged data

1. Select View Logged Data from the MAIN MENU. This will display the VIEW LOGGED DATA screen shown.
2. Select Choose from list of sites and select the site name for the log you want to print.
3. When you are ready to begin printing the log select Download log.
4. From the DOWNLOAD LOG screen select RS232. This will open the SETUP RS232/USB screen shown below.

VIEW LOGGED DATA	DD-MM-YY	HH:MM:SS
Choose from list of sites		
View log as text		
View log as graph		
Graph Y axis max. :		1.00
Download log		
Clear log		
Exit		

5. Select Send from the DOWNLOAD LOG screen. The printer should now start printing.
6. The message screen will be displayed while printing takes place (see next page).

DOWNLOAD LOG	DD-MM-YY	HH:MM:SS
Select Serial port or printer & press ↵		
USB		
RS232		
Exit		

DOWNLOAD LOG	DD-MM-YY	HH:MM:SS
Send		
Exit		

- Printing will continue until all logged data is output or until the \leftarrow key is pressed.

The printer will continue printing until its print buffer is empty, which may take a few minutes.

```

SETUP RS232/USB          DD-MM-YY  HH:MM:SS
Data is being downloaded on RS232

This screen will clear
when download is completed.
Press  $\leftarrow$  to cancel Download
    
```

4.8 Operation with the Calec®ST Energy Totaliser

The U3000/U4000 can be operated with the Calec® ST Energy Totaliser, which allows accumulated Energy measurement to be made. In this configuration, one Pt100 (or Pt500) temperature sensor is fitted to the output pipe (hot side) and another to the return pipe (cold side). The temperature difference ($\Delta T = T_{hot} - T_{cold}$), measured by the Calec® ST Energy Totaliser, together with the pulse input from the U3000/U4000, allows the Calec® ST Energy Totaliser to calculate and display the accumulated Energy absorbed by the heating system.

4.8.1 Pulse output

When working with the Calec® ST Energy Totaliser, the U3000/U4000 normal pulse output is not used. Instead, a pulse whose frequency is proportional to the flow rate is independently generated and output on ALARM1 or ALARM2 outputs. This gives a more stable reading, than the pulse "packets" that would normally be output.

4.8.2 Connecting the U3000/U4000 to the Calec® ST Energy Totaliser

Connect the U3000/U4000 to the Calec® ST Energy Totaliser as follows:

- Connect ALARM1+ (or ALARM2+) to the Calec's Pulse input + (10)
- Connect ALARM1- (or ALARM2-) to the Calec's Pulse input - (11)

4.8.3 Configuring the U3000/U4000

Configure the U3000/U4000 frequency pulse output using the following procedure:

- From the FLOW READING screen, press the Options key to select the FLOW READING OPTIONS menu, shown.

Note: You may need to enter the password first.

- Scroll down to Alarm Settings and press ENTER to select the ALARM SETTINGS menu shown below.

```

FLOW READING OPTION  DD-MM-YY  HH:MM:SS
Data review
Zero Cutoff (m/s)   :      0.010
Set zero flow (m/s) :      0.000
Damping (secs)     :      10
Totaliser           :      Run
Reset +Total

Reset -Total
Calibration factor  :      1.000
Roughness factor    :      0.010
Alarm Settings
Max Pulse Freq (Hz) :      10.00
Flow at Max Frequency :    200.00
Calculated Pulse Value:    2.00
Diagnostics
Exit
    
```

3. Select Alarm 1 Mode and press ENTER to select the ALARM1 MODE menu shown below:

```
ALARM SETTINGS          DD-MM-YY  HH:MM:SS
Alarm1 Mode             Off
Alarm1 Level           :
Alarm2 Mode            Off
Alarm2 Level           :
Exit
```

4. Scroll down to Frequency and press ENTER.
 5. This return to the ALARM SETTINGS menu which will indicate Frequency on the Alarm 1 Mode field as shown below.

```
ALARM1 MODE            DD-MM-YY  HH:MM:SS
Off
Low
High
Volume
On Flow Error
Alarm Test
```

Frequency

6. Select Exit to return to the FLOW READING OPTIONS menu.

```
ALARM SETTINGS          DD-MM-YY  HH:MM:SS
Alarm1 Mode             Frequency
Alarm1 Level           :
Alarm2 Mode            Off
Alarm2 Level           :
Exit
```

7. Scroll down to select Max Pulse Freq. (Hz) and press ENTER.
 8. Enter either 10Hz or 200Hz and press ENTER.
 9. Select Flow at Max Frequency and press ENTER.
 10. Enter the maximum flow rate (in litres per second) corresponding to 10Hz (or 200Hz) and press ENTER.
 11. The Calculated Pulse Value should indicate a value which must be used by the Imp value on the Calc. This is a non-editable value.
 12. Select Exit and press ENTER to return to the FLOW READING screen. The message 'Frequency Pulse is ON' should now be displayed on the status line of the display (line 2).

```
FLOW READING OPTION    DD-MM-YY  HH:MM:SS
Data review
Zero Cutoff (m/s)     :      0.010
Set zero flow (m/s)   :      0.000
Damping (secs)        :      10
Totaliser              :      Run
Reset +Total
```

```
Reset -Total
Calibration factor    :      1.000
Roughness factor      :      0.010
Alarm Settings        :
Max Pulse Freq (Hz)   :      10.00
Flow at Max Frequency :      200.00
Calculated Pulse Value:      2.00
Diagnostics
Exit
```

Note: ALARM 2 can be used instead of ALARM 1. The procedure is identical except that Alarm 2 Mode is selected and the frequency pulse output is connected to ALARM2+ and ALARM2-.

4.8.4 Configuring the Calec® ST Energy Totaliser

Two parameters need to be entered to allow operation with the U3000/U4000. These are:

Maximum Input Frequency

The *Maximum Input Frequency* should be the same as that set in the U3000/U4000, i.e. 10Hz or 200Hz.

Volume per pulse (Imp)

The *Volume per pulse* value should be the same as that indicated in the U3000/U4000 Calculated Pulse Value.

Both of these values can be entered using the Calec's Inputs menu. Refer to the Calec's User Manual for further details.

Example

Consider the U3000/U4000 configured as follows for a 114mm stainless steel pipe:

Max Pulse Freq. (Hz) = 200Hz
Flow at max Freq = 20.0 l/s
Calculated Pulse Value = 0.1

The U3000/U4000 reads a mean flow rate of 72.08 m³/h.

1. Select Calec Inputs and program as follows:

F = 200Hz
Imp = 0.1

2. Select Calec Instant then scroll to:

$\Delta T = 36.78^{\circ}\text{K}$
P = 3043.344
Q = 72.023
K = 1.149

The calculated value of P is given by: $P = k \times Q \times \Delta T = 3043.7\text{kW}$

This verifies the correct U3000/U4000 with the Calec® ST Energy Totaliser.

5: Maintenance & Repair

This instrument does not contain any user-serviceable parts. The following notes are provided as a guide to general equipment care



WARNING

**Do not disassemble this unit unless advised by Micronics.
Return the unit to an approved service agent or place of purchase
for further advice.**

1. Ensure the unit is disconnected from the mains, then wipe the exterior of the instrument with a clean, damp cloth or paper towel. Do not use a solvent-based cleaning fluid on the instrument as it could damage the instrument surface.
2. Ensure all cables and connectors are kept clean and free from grease or contaminants. Connectors may be cleaned with a general purpose cleaner if necessary.
3. Avoid the use of excessive grease/ultrasonic couplant on the sensors as this may impair the performance of the equipment. Excessive grease/couplant can be removed from the sensors and guide rails using an absorbent paper towel and a general purpose solvent cleaner.
4. We recommend that the ultrasonic couplant is replaced on the sensors every 6 months, especially on pipes where the application is too hot to touch. If the signal level drops below 30% this is also an indication that the sensors need re-greasing.
5. Regularly check all cables/parts for damage. Replacement parts are available from Micronics.
6. Ensure the person who services your instrument is qualified to do so. If in doubt, return the instrument to Micronics with a detailed report of the nature of any problem.
7. Take suitable precautions when using any materials to clean the sensors.
8. The instrument and sensors should be calibrated at least once every 12 months. Contact Micronics or your local service agent for details.
9. When returning product to Micronics make sure it is clean and please notify Micronics if the instrument has been in contact with any hazardous substances.
10. If the instrument was supplied with dust or dirt caps make sure they are re-fitted when the instrument is not in use.

6: Troubleshooting

6.1 Overview

If you have a problem with your flow monitoring system it can be due to any of the following:

Faulty instrument

Blank instrument display:

- Loss of power supply to the instrument.
- Internal power supply fuse ruptured.

Scrambled instrument display

- Reboot the instrument by temporarily disconnecting its power supply.

Incorrect setup

A low, or zero, signal could be caused by incorrect set-up such as:

- Incorrect site data entered into the instrument.
- Incorrect or non-matching ultrasonic transducers selected for use.
- Incorrectly fitted transducers – lack of couplant applied, incorrect spacing, insecure attachment.
- Poor connections between the probes and the instrument.

Application problem

If you are certain that the instrument is healthy and suitably set-up for the current site; and the probes are properly assembled and fitted correctly, there could be an application problem concerned with the site.

Check such conditions such as:

Poor pipe outer surface quality

- Uneven surface preventing good surface contact with the transducer.
- Flaking paint (should be removed).
- Variable air gap in concrete-covered pipes affecting the ultrasonic signal quality.

Poor internal pipe construction

- Rough internal pipe walls affecting fluid flow (see roughness factor).
- Internal welds positioned in the transducer signal path affecting the signal quality.
- The 'drippings' in galvanised-dipped pipes or other irregularities interfering with the signal path.

Incorrect probe location

- Transducers located too close to bends or valves, disturbing the flow profile.
- Transducers located too close to insertion probes, disturbing the flow profile.
- For horizontal pipework transducers should not be positioned on the top of the pipe.

Poor fluid conditions within the pipe

- Fluid contains bubbles, high particle density or sludge.
- Air in the top of the pipe.

Low fluid flow within the pipe

- Pipe obstructions.
- Malfunctioning valve not opening fully (or closed inadvertently).

Liquid content problems

- Multiple liquid contents do not comply accurately to expected sound speed criteria.
- Very hot pipe almost turns water to steam and therefore exhibits the wrong speed characteristics – could be due to reduced pipe pressure.
- Flashover – liquid turns into a gas because of lower than required pressure.

6.2 General Troubleshooting Procedure

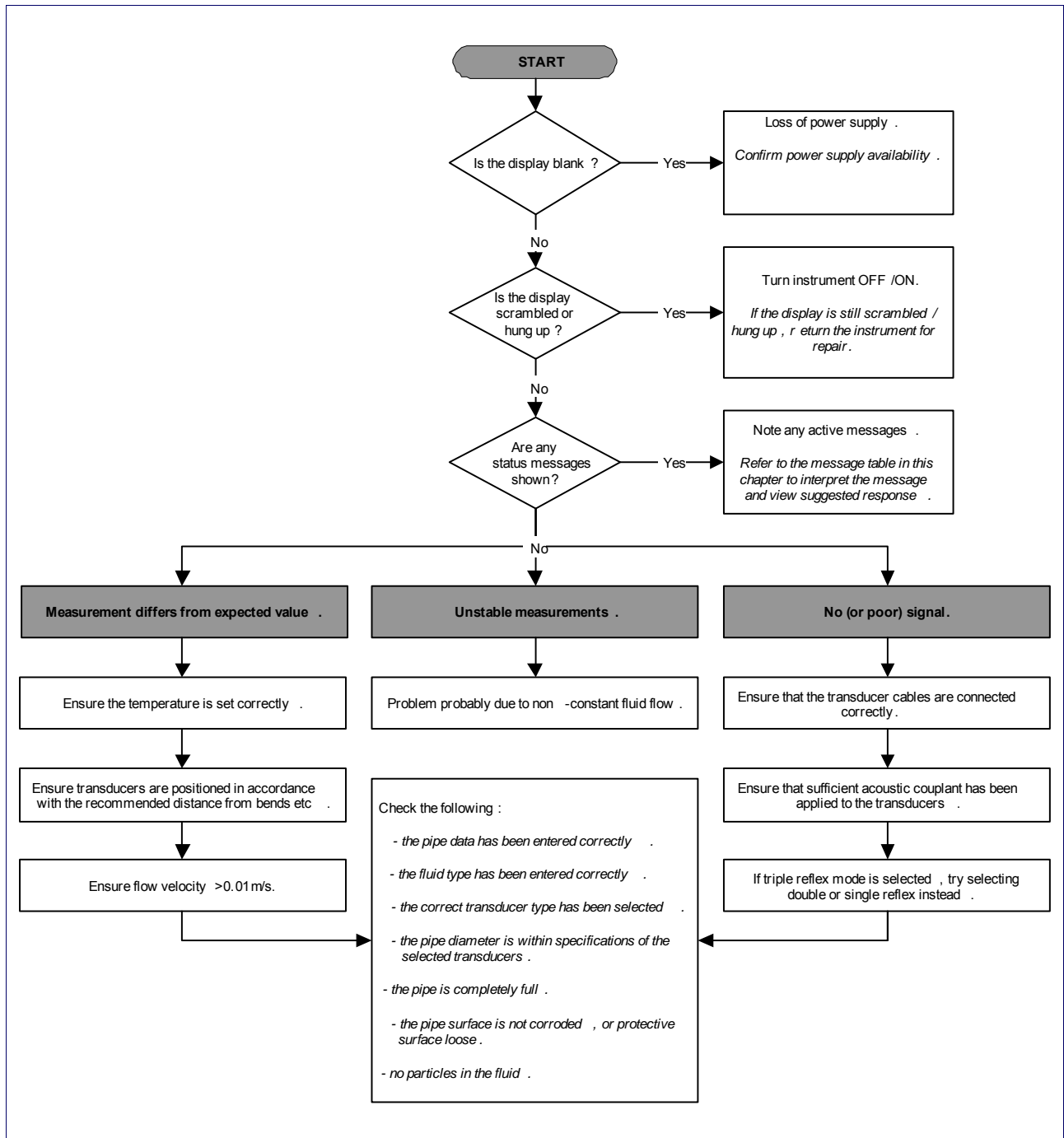

Figure 6.1 Troubleshooting chart

6.3 Warning and Status Messages

FLOW RATE ERRORS	
ERR:No flow signal	<p>Interpretation: This message appears when the transducers cannot send or receive signals to each other.</p> <p>Response: Firstly check that all cables are connected, transducers are on the pipe correctly with sufficient couplant on the face. This condition could also be due to a partially empty pipe, aerated liquid, particulate content too high or when the condition of the pipe being measured is poor.</p>
Flow signal is poor	<p>Interpretation: This warning appears when the signal is lower than 25%.</p> <p>Response: This could be due to an application problem, a poor quality pipe – see also the conditions for No flow signal (above). Check for sufficient couplant.</p>
ERR:Zero cut-off!	<p>Interpretation: You have entered an out-of-range value in the Zero cutoff field in the Options menu.</p> <p>Response: Enter a valid number.</p>
Totaliser beyond maximum!	<p>Interpretation: The totaliser has overflowed its maximum count. The counter will roll-over and restart from zero but this message alerts you to the fact.</p> <p>Response: Reset the totaliser as described in Paragraph 3.5.</p>
PULSE ERRORS	
ERR:Pulse output!	<p>Interpretation: The flow rate exceeds the capability of the pulse output – i.e. too many pulses per second are required than can be achieved.</p> <p>Response: Narrow the pulse width time or increase the volume per pulse, as described in Paragraph 3.4.2.</p>
ERR:Pulse volume!	<p>Interpretation: You have entered an out-of-range value in the Pulse volume error field in the PULSE OUTPUT menu – see Paragraph 3.4.2.</p> <p>Response: Enter a valid number.</p>
ERR:Pulse width!	<p>Interpretation: You have entered an out-of-range value in the Pulse width error field in the PULSE OUTPUT menu – see Paragraph 3.4.2.</p> <p>Response: Enter a valid number.</p>

4-20mA ERRORS	
Calibration 20mA Error!	<p>NOTE: The 4-20mA output is calibrated before the instrument leaves the factory and should not require further adjustment.</p> <p>Interpretation: You have adjusted the DAC outside its accepted range when calibrating the 20mA signal output.</p> <p>Response: Re-calibrate the 4-20mA output – see Paragraph 3.4.1.</p>
Calibration 4mA Error!	<p>NOTE: The 4-20mA output is calibrated before the instrument leaves the factory and should not require further adjustment.</p> <p>Interpretation: You have adjusted the DAC outside its accepted range when calibrating the 4mA signal output.</p> <p>Response: Re-calibrate the 4-20mA output – see Paragraph 3.4.1.</p>
DATA LOGGING ERRORS (U4000 only)	
ERR:Log not empty!	<p>Interpretation: When using QuickStart and manually starting a log, this message is displayed to warn you that a log already exists. The screen will offer the option to cancel the logging, or save the log to another site.</p> <p>Response: Attempt to save the existing log, then re-start logging. If logging still fails to start, and the error message remains, then either all the sites are in use or all the Logger memory is full. Check for any unwanted log files and delete them.</p>
ERR:Log memory full	<p>Interpretation: This occurs when all the data logger memory locations are filled. The effect on the logging process will depend on the setting of the Memory rollover field in the REAL TIME LOGGER screen (which may be set to Stop or Overwrite).</p> <p>Response: Clear the logger memory, as described in Paragraph 4.2.</p>

SET-UP ERRORS	
ERR:Pipe OD range!	<p>Interpretation: You have entered an out-of-range value for the pipe outside diameter dimension – i.e. larger or smaller than the unit or sensor can be used on.</p> <p>Response: Enter a valid number.</p>
ERR:Wall thk. range!	<p>Interpretation: You have entered an out-of-range value for the pipe wall thickness dimension – accepted range is 1mm - 75mm.</p> <p>Response: Enter a valid number.</p>
ERR:Lining thick. range!	<p>Interpretation: You have entered an out-of-range value for the lining thickness dimension – acceptable range is 0mm - 25mm.</p> <p>Response: Enter a valid number.</p>
ERR:Temperature range!	<p>Interpretation: You have entered an out-of-range value for the fluid Temperature. Accepted temperature range -20°C to +200°C.</p> <p>Response: Enter a valid number.</p>
ERR:Invalid Date or Time!	<p>Interpretation: The entered Date or Time is invalid, or when setting up 'timed' data logging the Stop time is set earlier than the Start time.</p> <p>Response: Enter a valid Date and Time.</p>
ERR:Invalid Sensor or Mode	<p>Interpretation: The selected temperature is higher than the maximum allowed for the sensor type.</p> <p>Response: Change the temperature.</p>
Mode: Err Type	<p>Interpretation: The selected sensors are invalid and the mode cannot be verified.</p> <p>Response: Choose a mode that gives a non-zero separation distance.</p>

6.4 Diagnostics Display

This feature is designed for advanced users and is intended to provide information that will aid the user to diagnose problems – e.g. no signal strength.

When operating in the FLOW READING mode you can access a diagnostics screen by pressing the Options function key and then selecting Diagnostics from the FLOW READING OPTIONS screen. This will display the operating values for the following parameters.

Calculated time (μ s)

This is a value the instrument predicts will be the time in μ secs that it should take for the acoustic wave to propagate across a particular pipe size. This value is ascertained from the data entered by the user. i.e. Pipe size, material, sensor set etc.

Actual time (μ s)

This is the value the instrument measures as the time taken for the acoustic wave to propagate across the pipe. It is used to see if the signal is being taken from the burst, at the correct time to get the strongest signal. This value is normally a few μ s below the calculated μ s value. If, however, this value is much greater than the calculated time then there is a problem with the set-up.

Flow (m/s)

This displays flow velocity in m/sec to 3 decimal places.

Signal strength

This is the averaged value of Signal and should be a value between 800 and 1600 – where 800 is approximately 50%, and 1600 is approximately 100%.

Gain

Gain values are typically in the range 600 to 850.

Switches

Typical Switches values are None and *10. On small pipes (and when using the test block) the value should be None. A Switch value of *100 indicates poor sensor set-up or poor connections.

UP/DN time difference

The difference in transit times between the upstream and downstream signals due to the fluid flow.

Fluid propagation rate

This is the sound speed of the fluid calculated using the data entered by the user.

Sensor separation

The same value as displayed in the setup screen.

7: Options

7.1 Options Common to Both the U3000/U4000

The following options are common to both the U3000 and U4000 instruments:

7.1.1 Large pipe diameter transducers

Type 'D' transducers are available for use with pipe diameters in the range 1500mm to 5000mm, operating over the temperature range -20°C to +80°C. The type 'D' transducer kit is supplied in a separate case and includes the sensors together with ratchet straps and guide rails for attaching to the pipe.

7.1.2 Guide rail options

The standard method of securing the guide rail to the pipe is by stainless steel banding.

7.1.3 Extended signal cable options

Normally the U3000/U4000 is supplied with cables of either 5 or 10m in length.

If required, custom signal cables with lengths up to 100m can also be supplied. Consult Micronics Ltd for further information and availability.

Appendix A: Specification

GENERAL	
DSP Measurement Technique:	Transit time.
Timing Resolution:	50 pico-second, continuous signal level indication on display.
Flow Velocity Range:	Minimum Velocity 0.1m/s; Max Velocity 10m/s: Bi-directional.
Turn Down Ratio:	200:1
Accuracy:	±0.5% to ±2% of flow reading for flow rate >0.2m/s and Pipe OD >75mm. ±3% of flow reading for flow rate >0.2m/s and Pipe OD in range 13mm - 75mm. ±6% of flow reading for flow rate < 0.2m/s.
Repeatability:	±0.5% of measured value or ±0.02m/s whichever is the greater.
Reynolds Number Correction:	Flow velocity corrected for Reynolds number over entire velocity range.
Response Time:	< 500ms depending on pipe diameter.
Selectable Flow Units:	VELOCITY: m/sec, ft/sec. VOLUME: l/s, l/min, l/h, gal/s gal/min, gal/h, USgals/s, USgals/min, USgals/h, Barrel/h, Barrel/day, m³/s, m³/min, m³/h.
Selectable Volume Units:	litres, m³, US gallons, gallons, barrels (oil).
Total Volume:	12 Digits - forward and reverse.
APPLICABLE FLUID TYPES	
Fluid Condition:	Clean liquids or oils that have less than 3% by volume of particulate content. Applications include river water, sea water, potable water, demineralised water, glycol/water mix, hydraulic systems and diesel oil.
APPLICABLE PIPE TYPES	
Pipe Materials:	Any sonic conducting medium such as Carbon Steel, Stainless Steel, Copper, UPVC, PVDF, Concrete, Galvanised Steel, Mild Steel, Glass, Brass. Including Lined Pipes - Epoxy, Rubber, Steel, Plastic.
Pipe Dimension (outside diameter):	Min 13mm; Max 5000mm (with 'D' sensor set).
Pipe Wall Thickness:	1mm - 75mm.
Pipe Lining:	Applicable pipe linings include Rubber, Glass, Concrete, Epoxy, Steel.
Pipe Lining Thickness:	0mm – 25mm.
Pipe Wall Temperature Range:	Standard sensor operating temperature is -20°C to +135°C.

TRANSDUCER SETS	
Standard:	Temperature Range -20°C to +135°C. 'A-ST' (standard) 13 mm...115 mm pipe O.D. 'B-ST' (standard) 50 mm...2000 mm pipe O.D. Protection: IP51
Optional:	Temperature Range -20°C to +80°C (0.5MHz). 'D' 1500 mm...5000 mm pipe O.D.
DATA LOGGER (U4000 only)	
Data Logged:	Standard: All measurement parameters and flow reading Optional: Totalised values
No. data points:	Standard: 200k data points (may be affected by totaliser)
Time Stamping:	All data points are date & time stamped.
No. Sites:	1 (non-editable) and 1 (editable)
Logging Interval:	User programmable 5 secs to 1hr
Operating Modes:	Logging stopped when memory full Logging continues on memory overflow with old date overwritten.
Logged Data Transfer:	Logged data can be transferred to PC via RS232 or USB
LANGUAGES	
Standard Supported Languages:	English, French, German, Italian, Spanish, Portuguese, Russian, Norwegian, Dutch, Swedish.
OUTPUTS	
Serial Interface:	RS232 and USB 2.0 Full Speed (12Mbits/sec) mode, USB software driver provided.
Logged Data	Can be output to PC or Printer
Current Output: No. Channels Format: Resolution: Error Currents: Isolation: Maximum Load:	1 4–20mA, 0–20mA, 0–16mA. 0.1% of full scale. Any between 0–26mA. 1000V Opto-isolated from unit. 620 Ohms.
Pulse Output TTL: Number Available: Isolation: Pulse Repetition Rate: Pulse Width: Max Current: Max Voltage:	1 – Opto-isolated MOSFET relay. 1500V opto isolated from unit. User programmable from 1 to 250 pps. User programmable from 2ms to 500ms. 500mA. 48V.

Alarms:	
Number of Channels Available:	2 – opto-isolated MOSFET relay.
Isolation:	1500V opto isolated from unit.
Relay Contact Mode:	N/O when switching condition is False Closed when switching condition is True
Alarm Functions:	The two relays can be configured to operate when: <ul style="list-style-type: none"> • a predefined MINimum or MAXimum flow rate is exceeded. • a specified VOLume is measured. • a signal Error condition occurs • manual alarm test • pulse frequency
Frequency output:	Maximum 200Hz.
Max Current:	500mA.
Max Voltage:	48V.
ELECTRICAL	
Supply Voltage:	
Mains Input Voltage:	86V to 264V a.c.
Mains Input Frequency:	47Hz to 63Hz
Power Consumption:	10.5W.
Alternative Input Supply:	24Va.c./d.c. 1A max. (The 24Vac supply must be isolated from Earth.)
MECHANICAL	
Enclosure:	
Material:	ABS and aluminium.
Dimensions:	230mm x 180mm x 120mm
Weight:	1.2kg
Protection:	IP65
Fixing:	Wall mountable
Keypad:	
No. Keys:	15 key tactile feedback membrane keypad
Display:	
Format:	240 x 64 pixel graphic display, high contrast black-on-white, with backlight.
Viewing Angle:	Min 30°, typically 40°.
Active Area:	127mm (W) x 34mm (H)
Overlay:	Standard English, Optional overlays available
ENVIRONMENTAL	
Operating Temperature:	-20°C to +50°C.
Storage Temperature:	-25°C to +65°C.
Operating Humidity:	90% RH MAX at +50°C.

APPROVALS	
Safety:	BS EN 61010-1:2001
EMC:	BS EN 61326 - 1:2006, BS EN 61326-2-3:2006.
Environmental:	BS EN 60068-1:1995, BS EN 60068-2-1:2007, BS EN 60068-2-2:2007
SHIPPING INFORMATION	
Box Dimensions:	480mm x 320mm x 150mm.
Weight:	4.5 kg.
Volumetric Weight:	3.8 kg.
<i>Micronics reserve the right to alter any specification without notification.</i>	

CE Declaration of Conformity



MICRONICS

CE Declaration of Conformity

Micronics Ltd

Knaves Beech Business Centre
Davies Way, Loudwater,
High Wycombe, Bucks.
HP10 9QR

U3000-U4000 Ultrasonic Flowmeter

This product is manufactured in accordance with the following Directives and Standards.

Directive 2004/108/EC of the European Parliament and of the Council of 15 December 2004 on the approximation of the laws of the Member States relating to electromagnetic compatibility.

Directive 2006/95/EC of the European Parliament and of the Council of 12 December 2006 on the harmonisation of the laws of Member States relating to electrical equipment designed for use within certain voltage limits.

BS EN 61010-1:2001 Safety requirement for electrical equipment for measurement control and laboratory use. Part 1 General requirements

BS EN61326-1:2006 Electrical equipment for measurement control and laboratory use EMC requirements. Part 1: General requirements

BS EN61326-2-3:2006 Electrical equipment for measurement control and laboratory use EMC requirements. Part 2-3: Particular requirements – Test configuration and performance criteria for transducers with integrated or remote signal conditioning.

(Included accessory battery charger not manufactured by Micronics complies with EN61204 – 3)

I, the undersigned, hereby declare that the equipment specified above conforms to the above Directive(s) and Standard(s).

Signature:

Printed Name:

Michael Farnon

Title:

Managing Director

Date:

25th January 2010

Registered Office: Micronics Limited, Knaves Beech Business Centre, Davies Way, Loudwater, Buckinghamshire, HP10 9QR

Web site: www.micronicsltd.co.uk Tel: +44 (1628) 810456 Fax: +44 (1628) 531540

Directors: E.J. Farnon, M.A. Farnon

Registration No. 1289680 V.A.T. Registration No. 303 8190 91

